

LETBRO2306

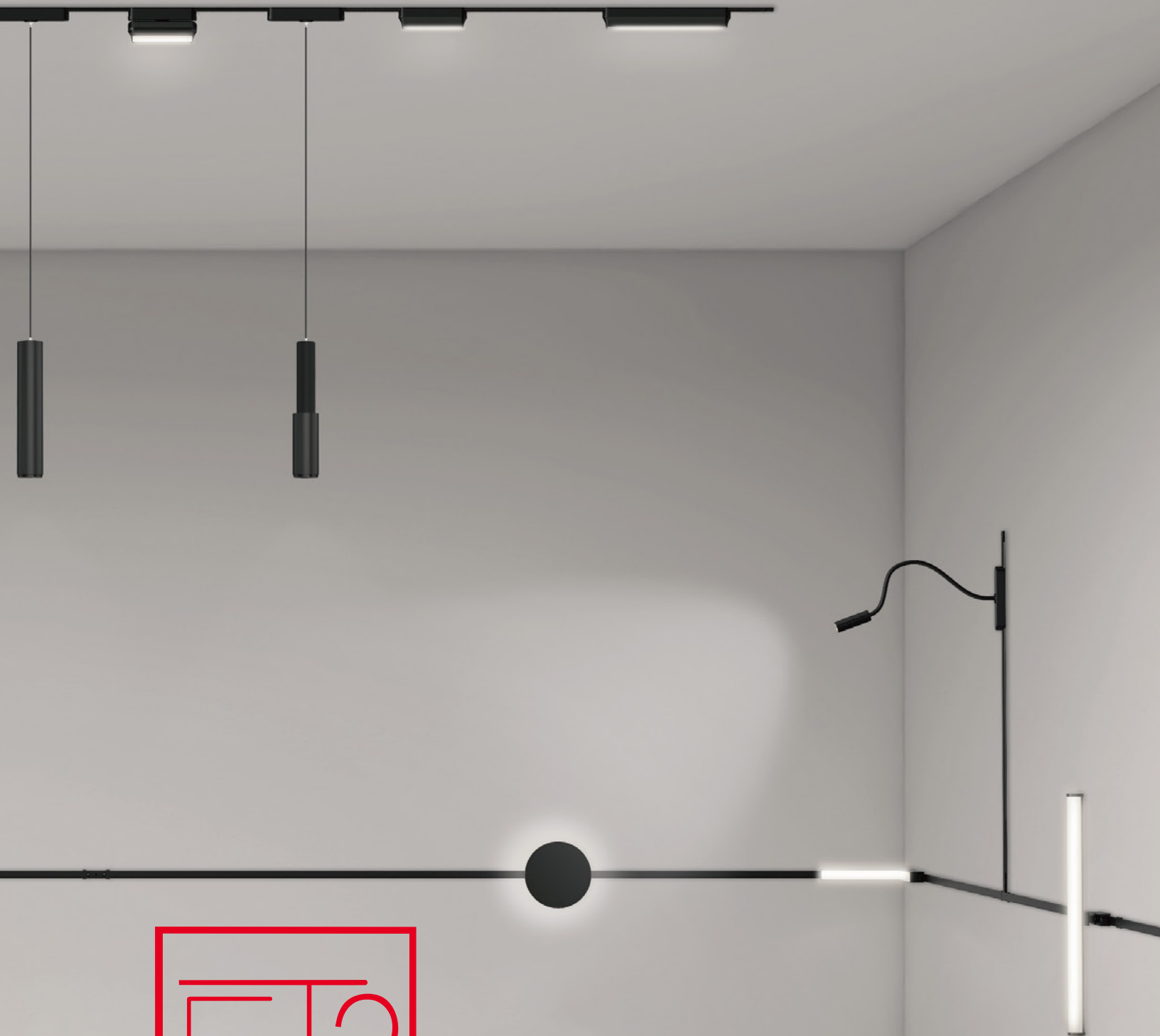



CONTINUUM
TRACK

CONTINUUM TRACK

The next generation of track lighting is here with the ultra-slim Continuum series from ET2.

Field adjustable track lengths can be extended, connected, or cut to fit the space they are installed. On them, a variety of low voltage light sources can be quickly snapped into place adding and directing light exactly where desired. Various power feed options are available including remote, on-track, or integrated dimmable driver and switch.

Available in Matte Black or Matte White, the track lengths can even be painted to match the exact paint color of the surface they are installed. This adaptable track system makes it simple to design the lighting in your space according to your vision and is only limited by your imagination.

- **Surface Mounted Installation**
- **Mount to both walls and Ceilings**
- **Ultra Slim Profile appears similar to recessed**
- **Various Lighting elements quickly click onto track**
- **Field adjustable**
- **Available in White and Black**
- **24 Volt System**





ON-TRACK DRIVER

24V Low Voltage Output
Plug-In and Hardwire Options



96W On-Track Driver
ETDRV001-24100BK, WT

11.5"L x 1"W x 2.25"H
Includes 48" Plug

INSTALL OPTION 1



PLUG-IN

INSTALL OPTION 2



HARDWIRE KNOCKOUT

INSTALL OPTION 3

DISCREETLY WIRE WITHIN
(Shown with Cover Plate)

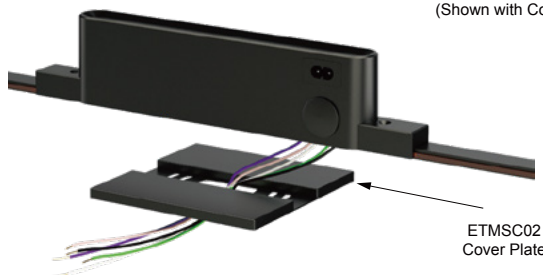

ETMSC02
Cover Plate

COVER PLATE ACCESSORIES



Track Cover Plate
ETMSC02-BK, -WT
5"L x 5"W x .25"H



Track Cover Plate
ETMSC03-BK, -WT
5"L x 5"W x .25"H

REMOTE HARDWIRED DRIVER



Hardwire Driver
(Remote Installation)
EDHW-2496BK
8.5"L x 3.25"W x 1.5"H

DRIVER & DIMMER SWITCH

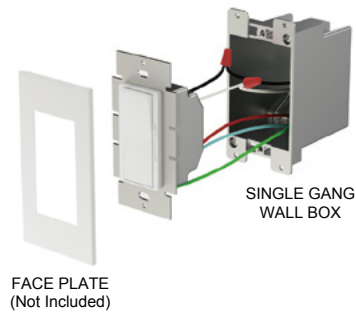

FACE PLATE
(Not Included)

SINGLE GANG
WALL BOX

60W Dimmer Switch
SWT898-2460WT
2.25"L x 2"W x 4.25"H

75W Dimmer Switch
SWT898-2475WT
2.25"L x 2"W x 4.25"H

SPLICE BOX

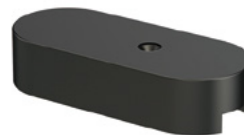

Splice Box
ETMSC04-BK, -WT
3"L x 1"W x 0.75"H



Track Length
(Sold Separately)



ELECTRICITY FEED & COVER PLATE



Electricity Module and Cover Plate
(Driver not included)
ETMSC01-BK, -WT
5"L x 5"W x 0.25"H

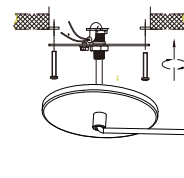

Track Length
(Sold Separately)

SURFACE MOUNTED TRACK



Surface Mount Installation
 Field Cuttable
 Various Track Connectors Adaptable
 Available in Black or White
 3M Stickers Cover Screw Caps

TRACK SIZES AVAILABLE:

ETRK25080-BK, -WT 33"

ETRK25150-BK, -WT 60"

ETRK25200-BK, -WT 80"

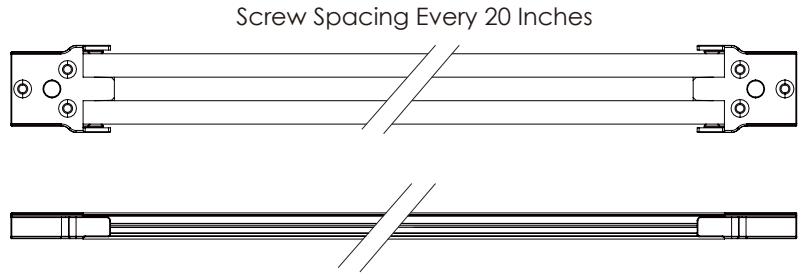

SURFACE MOUNTED CONNECTORS

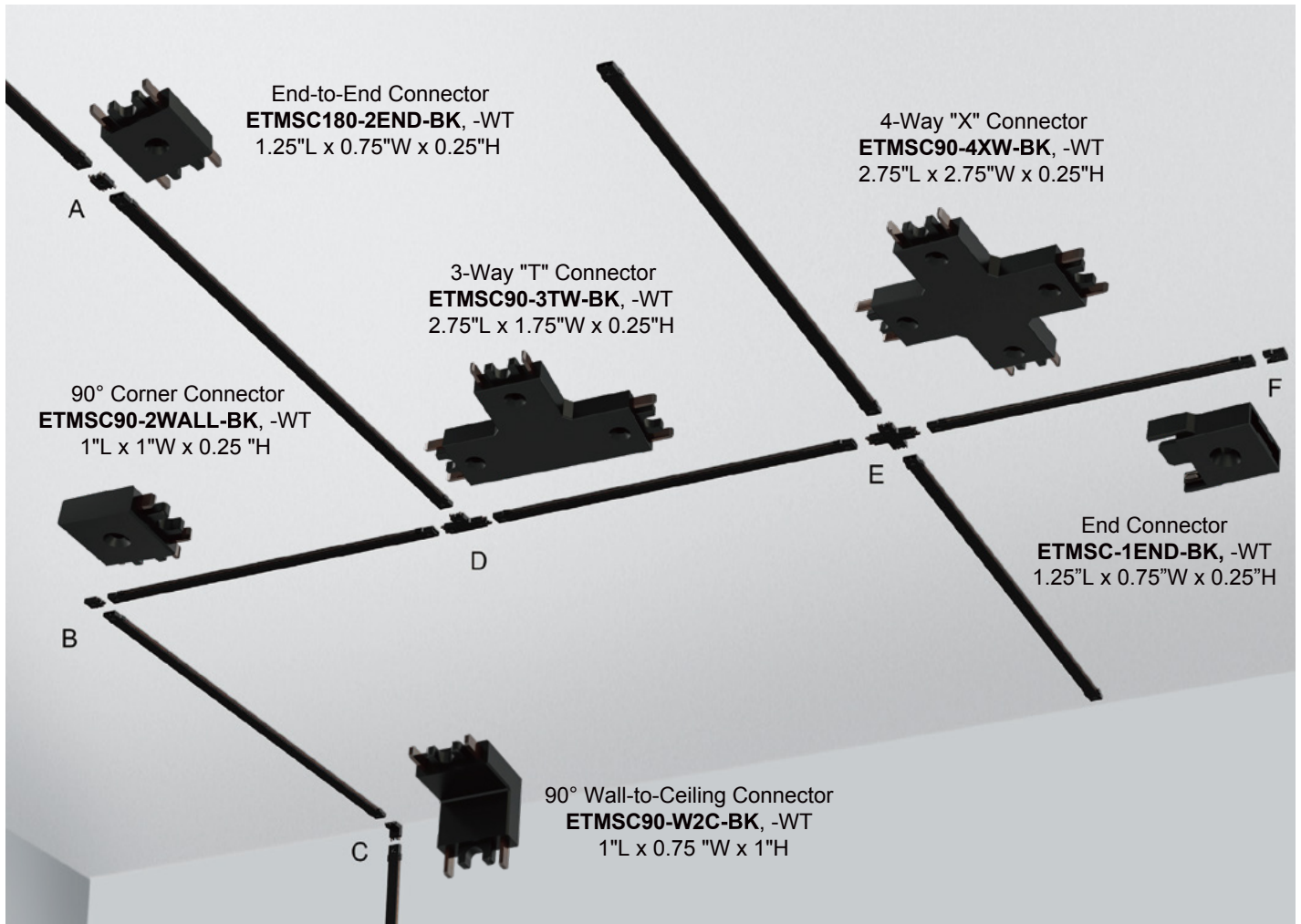

TRACK LIGHTS

• Flat Lens Diffuser with even light distribution • Available with adjustable gimbal • 24V LED, 3000K Color Temperature

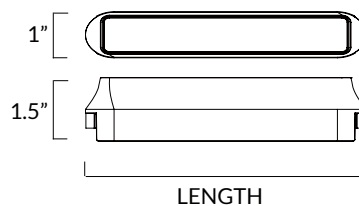
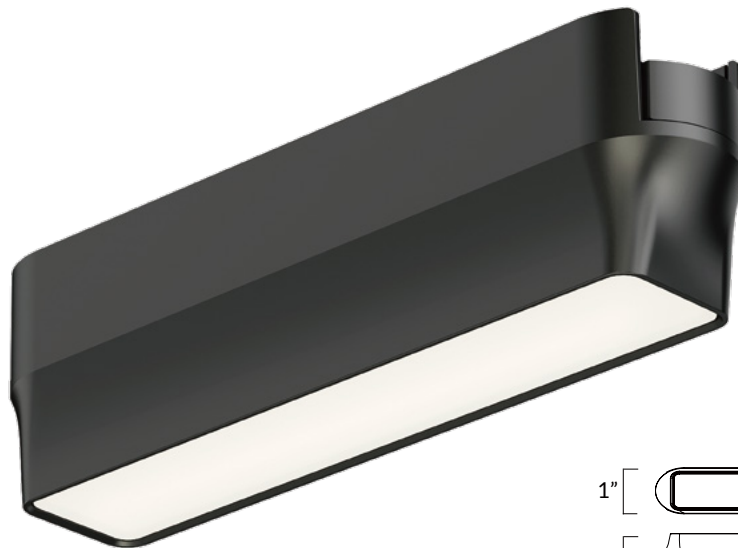

STANDARD LENS



ETL26212-WT

ETL26216-BK

ETL26218-BK

100°
STANDARD LENS

ITEM #	FINISH	LAMPING	DIMENSION	LUMENS			Additional Information
				CRI	INIT.	DEL.	
ETL26212	BK, WT	6W PCB LED 3000K (Inte.)	5"L x 1"W x 1.5"H	90+	600	300	
ETL26216	BK, WT	9W PCB LED 3000K (Inte.)	9"L x 1"W x 1.5"H	90+	900	450	
ETL26218	BK, WT	12W PCB LED 3000K (Inte.)	13.5"L x 1"W x 1.5"H	90+	1500	750	

Finish Options: Black (BK) White (WT)



ETL25212-BK

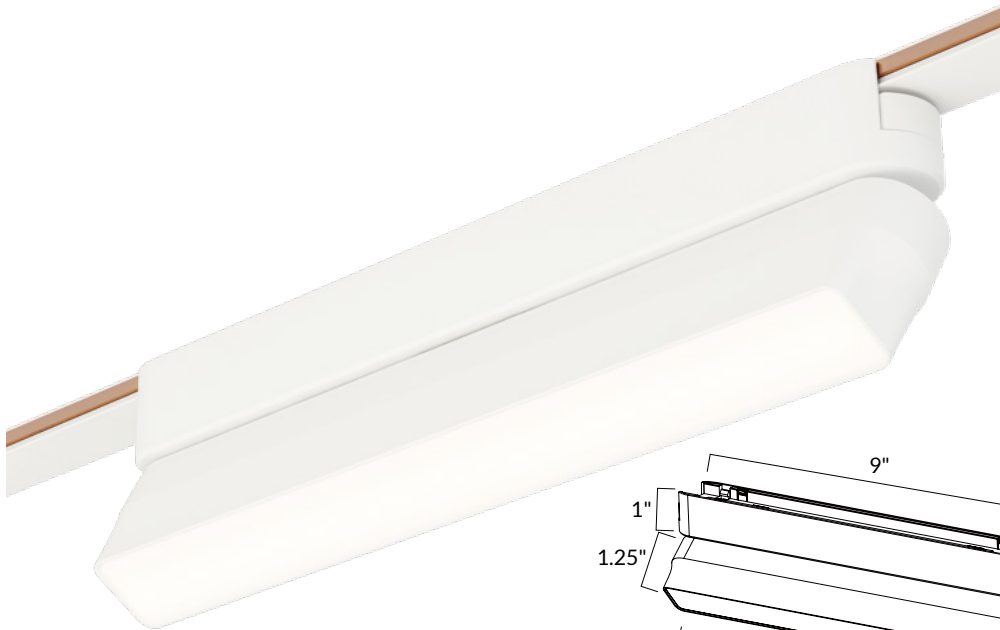
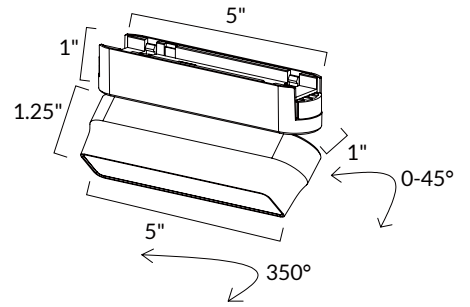

ETL25216-WT

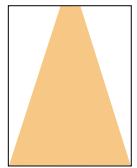
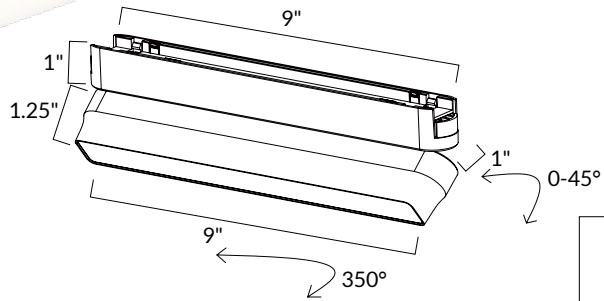

100°

STANDARD LENS
w/Gimbal

ITEM #	FINISH	LAMPING	DIMENSION	LUMENS			Additional Information
				CRI	INIT.	DEL.	
ETL25212	BK, WT	6W PCB LED 3000K (Inte.)	5"L x 1"W x 2.25"H	90+	600	300	
ETL25216	BK, WT	9W PCB LED 3000K (Inte.)	9"L x 1"W x 2.25"H	90+	900	450	

Finish Options: Black (BK) White (WT)

TRACK LIGHTS

• Flat Lens Diffuser with even light distribution • Available with adjustable gimbal • 24V LED, 3000K Color Temperature



OPTICAL LENS



ITEM #	FINISH	LAMPING	DIMENSION	LUMENS			Additional Information
				CRI	INIT.	DEL.	
ETL24212	BK, WT	6W PCB LED 3000K (Inte.)	5"L x 1"W x 1.5"H	90+	550	450	
ETL24216	BK, WT	9W PCB LED 3000K (Inte.)	9"L x 1"W x 1.5"H	90+	800	675	

Finish Options: Black (BK) White (WT)



ETL23212-BK

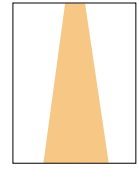
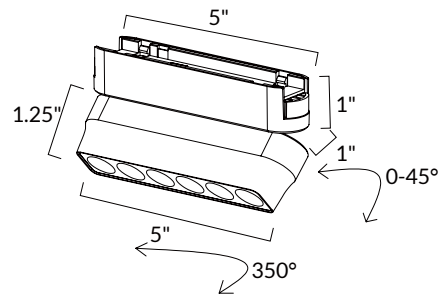

24°

OPTICAL LENS
w/ Gimbal



ETL23216-WT

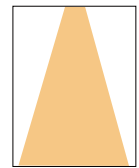
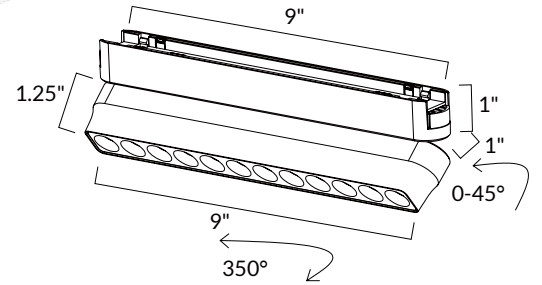

80°

ANTI-GLARE LENS

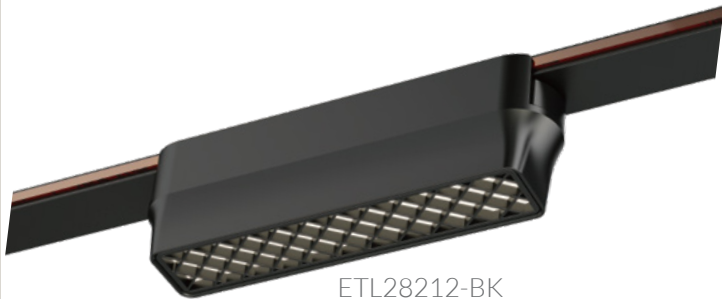

ETL28212-BK



ETL28216-WT

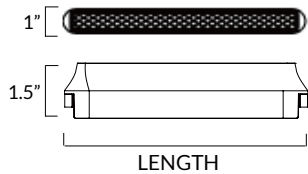

LENGTH

ITEM #	FINISH	LAMPING	DIMENSION	LUMENS		Additional Information
				CRI	INIT. DEL.	
ETL23212	BK, WT	6W PCB LED 3000K (Inte.)	5"L x 1"W x 2.25"H	90+	550 450	
ETL23216	BK, WT	9W PCB LED 3000K (Inte.)	9"L x 1"W x 2.25"H	90+	800 675	
ETL28212	BK, WT	6W PCB LED 3000K (Inte.)	5"L x 1"W x 1.5"H	90+	600 250	
ETL28216	BK, WT	9W PCB LED 3000K (Inte.)	9"L x 1"W x 1.5"H	90+	900 350	

Finish Options: Black (BK) White (WT)



ETL29222
90° Corner
Intersection

ETL29212
90° Flat
Corner

TRACK LIGHTS

- Corner Modules Illuminate at 90 degrees
- 24V Low Voltage LED, 3000K Color Temperature • 90 degree single surface module
- 90 degree Wall to Ceiling Module
- Flat PMMA Acrylic Diffusers
- Available in Black and White

CORNER LIGHTS

90° CORNER LIGHT

Single
Surface

ETL29212-WT

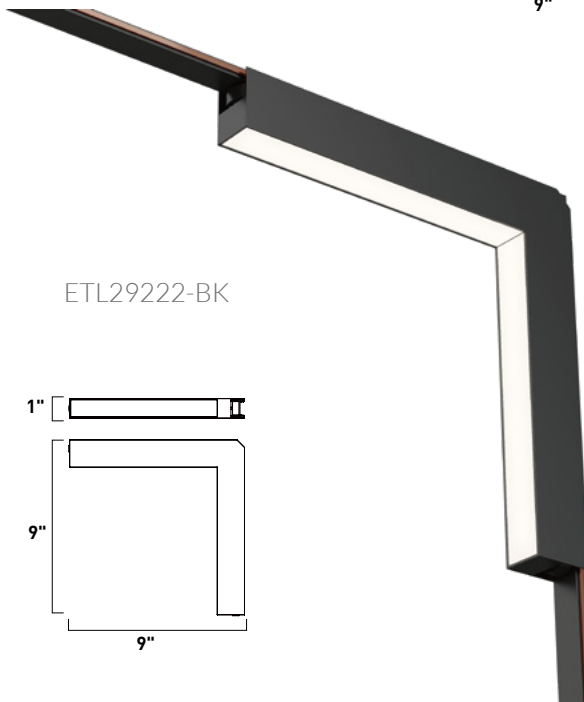
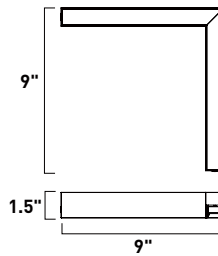



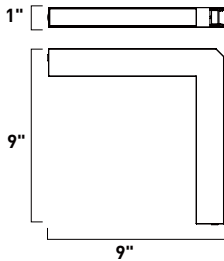





ETL29222-BK



WALL-TO-CEILING

LIGHT Two Plane
Surfaces

ITEM #	FINISH	LAMPING	DIMENSION	LUMENS		Additional Information
				CRI	INIT. DEL.	
ETL29212	BK, WT	15W PCB LED 3000K (Inte.)	9"L x 9"W x 1.5"H	90+	1500:950	   
ETL29222	BK, WT	15W PCB LED 3000K (Inte.)	9"L x 1"W x 9"H	90+	1500:950	   

Finish Options: Black (BK) White (WT)

SPOT LIGHTS

- Spot Lights to direct light where needed
- Different apertures and lumen packages available
- 24V Low Voltage LED 3000K Color Temperature Adjustable Beam Angle Models
- Available in Black and White with Black interior



A. ETL21212-BK, -WT

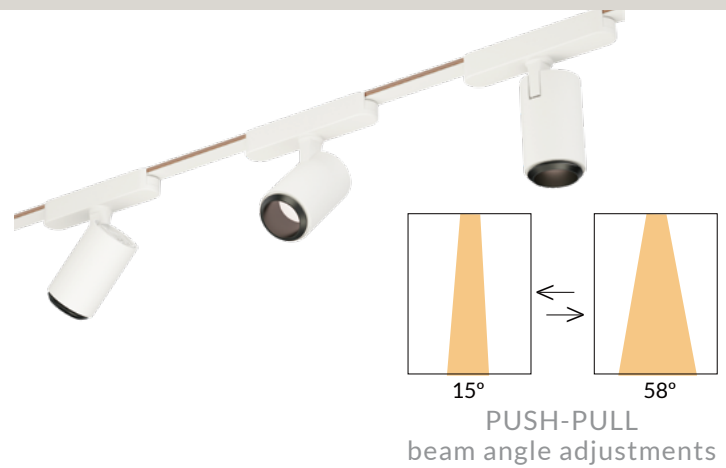

B. ETL21211-BK, -WT



ANTI-GLARE Lens Included

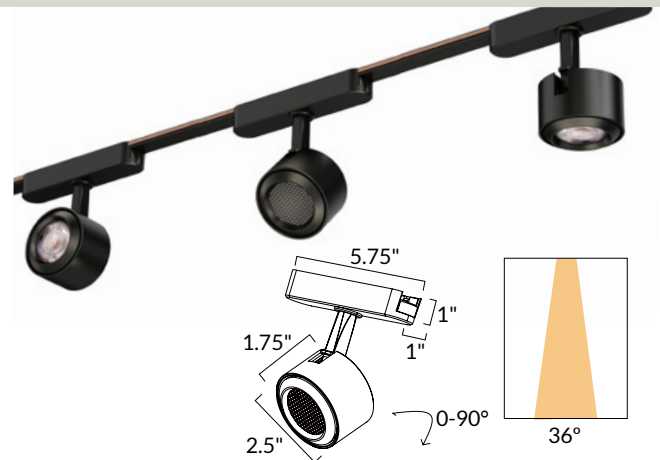

ITEM #	FINISH	LAMPING	DIMENSION	LUMENS			Additional Information
				CRI	INIT.	DEL.	
ETL21212	BK, WT	10W PCB LED 3000K (Inte.)	5.75"L x 2"W x 4.75"H	90+	900	300	
ETL21211	BK, WT	12W PCB LED 3000K (Inte.)	5.75"L x 2.5"W x 4.25"H	90+	1100	850	





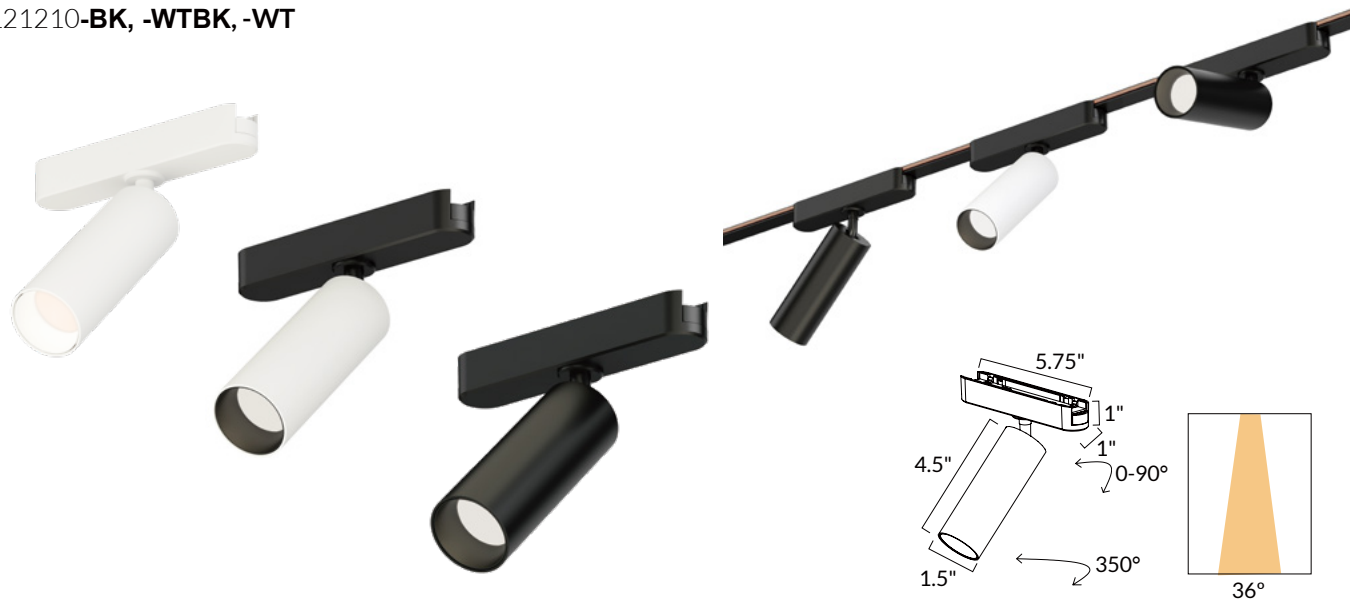



Finish Options: Black (BK) White (WT)

c. ETL21210-BK, -WTBK, -WT



d. ETL21214-BK, -WT



ITEM #	FINISH	LAMPING	DIMENSION	LUMENS	Additional Information
				CRI INIT. DEL.	
ETL21210	BK, WTBK, WT	7W PCB LED 3000K (Inte.)	5.75"L x 1.5"W x 5.75"H	90+ 650 500	   
ETL21214	BK, WT, 114BK, 114WT	5W PCB LED 3000K (Inte.)	5.75"L x 2.75"W x 4.25"H	90+ 450 350	   

Finish Options: Black (BK) White/Black (WTBK) White (WT)







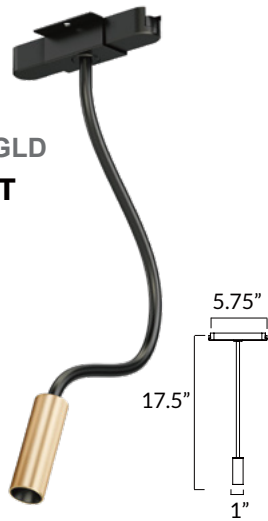

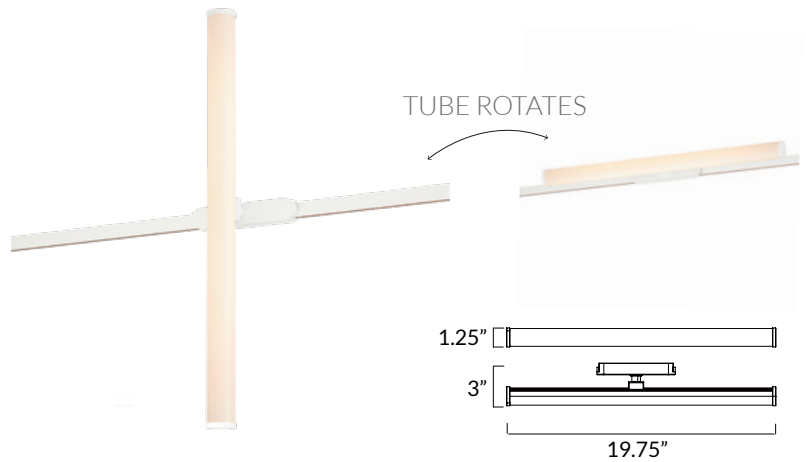

ETL21216-BK, -BKGLD

**READING LIGHT
FLEXIBLE ARM
HOLD POSITION
with touch switch**



ETL21232-BK, -WT
TUBE LIGHT



ITEM #	FINISH	LAMPING	DIMENSION	LUMENS			Additional Information
				CRI	INIT.	DEL.	
ETL21216	BK, BKGLD	2W PCB LED 3000K (Inte.)	5.75"L x 1"W x 17.5"H	90+	200	150	   
ETL21232	BK, WT	12W PCB LED 3000K (Inte.)	19.75"L x 1.25"W x 3"H	90+	1100	850	   

Finish Options: Black (BK) White (WT) Black/Gold (BKGLD)

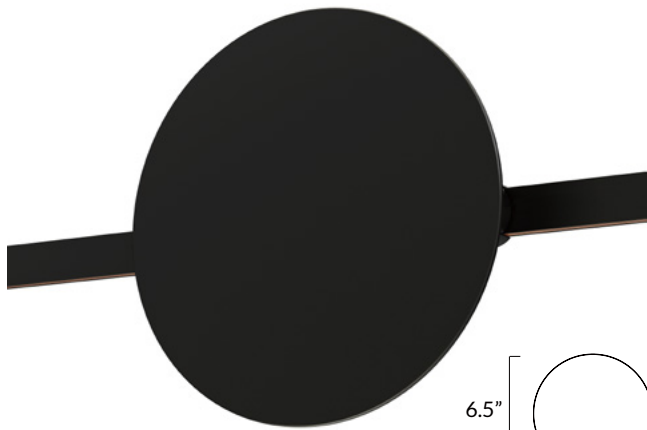

ETL29223

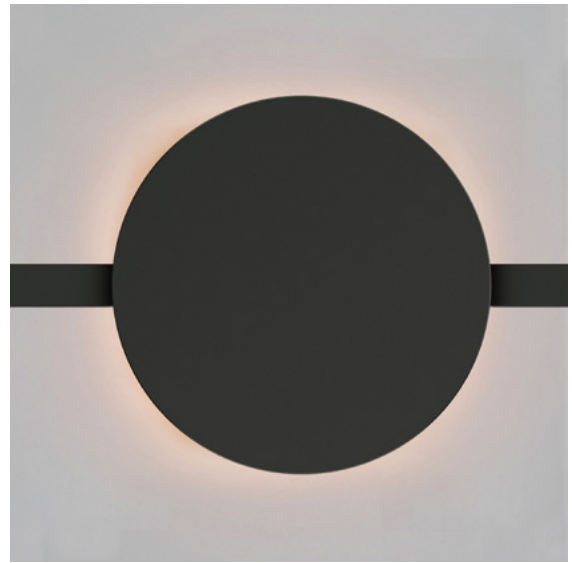
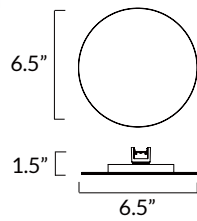







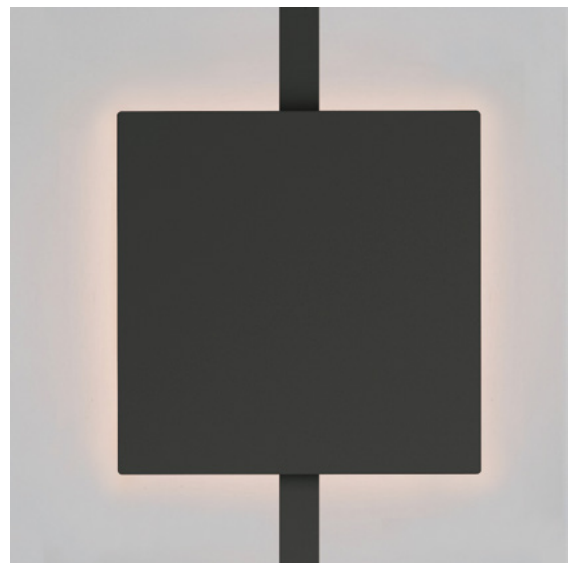
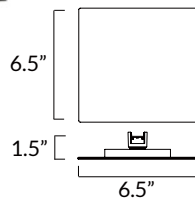

INDIRECT LIGHT



ETL29224



ITEM #	FINISH	LAMPING	DIMENSION	LUMENS			Additional Information
				CRI	INIT.	DEL.	
ETL29223	BK	5W PCB LED 3000K (Inte.)	6.5"L x 6.5"W x 1.5"H	90+	450	350	   
ETL29224	BK	5W PCB LED 3000K (Inte.)	6.5"L x 6.5"W x 1.5"H	90+	450	350	   

Finish: Black (BK)





ETL31003-WTBK



ETL31006-WTBK



ITEM #	FINISH	LAMPING	DIMENSION	LUMENS			Additional Information
				CRI	INIT.	DEL.	
ETL31003	WTBK	12W PCB LED 3000K (Inte.)	39.25"L x 1.25"W	90+	600	600	  
ETL31006	WTBK	20W PCB LED 3000K (Inte.)	78.5"L x 1.25"W	90+	1000	1000	  

Finish: White/Black (WTBK)

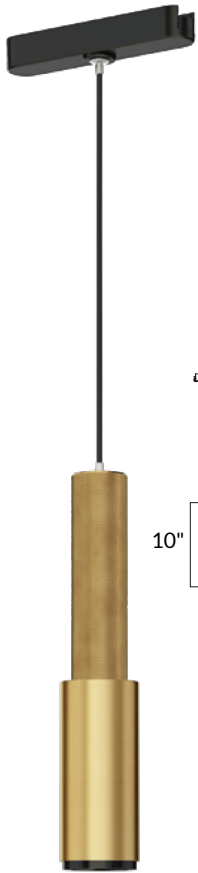

ETL31622-BK, **-NAB**, -WT



ETL31022-**BK**, -NAB, -WT

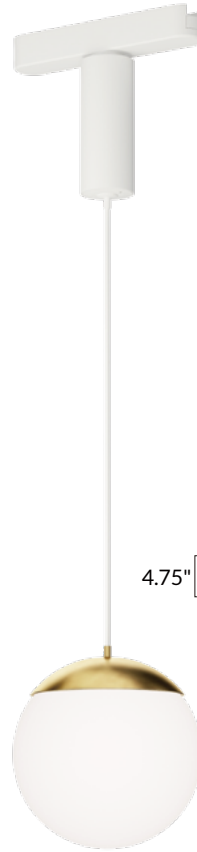

ETL31013-WT, **-WTNAB**

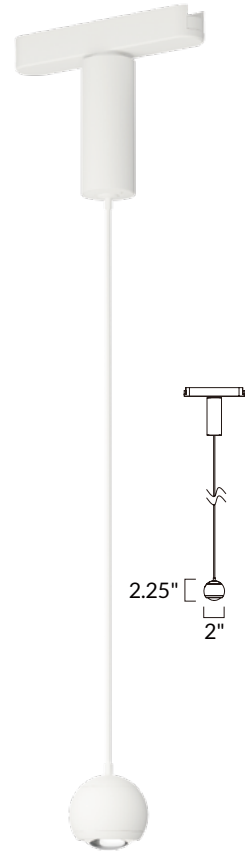

ETL31251-BK, -NAB, **-WT**



ITEM #	FINISH	LAMPING	DIMENSION	LUMENS			Additional Information
				CRI	INIT.	DEL.	
ETL31622	BK, NAB, WT	5W PCB LED 3000K (Inte.)	2"L x 2"W x 10"H, 69"OAH	90+	450	350	LED DIM 124 ⓘ
ETL31022	BK, NAB, WT	5W PCB LED 3000K (Inte.)	2"L x 2"W x 10"H, 69"OAH	90+	450	350	LED DIM 124 ⓘ
ETL31013	WT, WTNAB	5W PCB LED 3000K (Inte.)	4.75"L x 4.75"W x 4.75"H, 63.75"OAH	90+	450	350	LED DIM 124 ⓘ
ETL31251	BK, NAB, WT	5W PCB LED 3000K (Inte.)	2"L x 2"W x 2.25"H, 61.25"OAH	90+	450	350	LED DIM 124 ⓘ

Finish Options: Black (BK) Natural Aged Brass (NAB) White (WT)

INDEX



SURFACE MOUNTED TRACK

	ETRK25080	-BK, -WT	33"L
	ETRK25150	-BK, -WT	60"L
	ETRK25200	-BK, -WT	80"L

SURFACE MOUNTED CONNECTORS

	ETMSC180-2END	-BK, -WT	END-TO-END
	ETMSC90-W2C	-BK, -WT	WALL to CEILING
	ETMSC90-2WALL	-BK, -WT	90° CORNER
	ETMSC90-3TW	-BK, -WT	90° CORNER 3-WAY "T"
	ETMSC90-4XW	-BK, -WT	90° CORNER 4-WAY "X"
	ETMSC-1END	-BK, -WT	END Connector



POWER SUPPLIES & ACCESSORIES

	ETDRV001-24100	-BK, -WT	96W On-Track Driver
	EDHW-2496	BK	Remote Hardwired Driver
	ESWT898-2460	WT	60W Dimmable Driver Switch
	ESWT898-2475	WT	75W Dimmable Driver Switch
	ETMSC01	-BK, -WT	Electricity Module & Cover Plate
	ETMSC02	-BK, -WT	Track Cover Plate
	ETMSC03	-BK, -WT	Track Cover Plate
	ETMSC04	-BK, -WT	Splice Box

TRACK LIGHTS

	ETL26212	-BK, -WT	5" FLAT LENS		ETL23212	-BK, -WT	5" ADJUSTABLE OPTICAL LENS
	ETL26216	-BK, -WT	9" FLAT LENS		ETL23216	-BK, -WT	9" ADJUSTABLE OPTICAL LENS
	ETL26218	-BK, -WT	13.5" FLAT LENS		ETL21232	-BK, -WT	OPTICAL LENS TUBE LIGHT
	ETL25212	-BK, -WT	5" ADJUSTABLE FLAT LENS		ETL21216	-BK, -BKGLD	READING LIGHT
	ETL25216	-BK, -WT	9" ADJUSTABLE FLAT LENS				
	ETL24212	-BK, -WT	5" OPTICAL LENS				
	ETL24216	-BK, -WT	9" OPTICAL LENS				
	ETL28212	-BK, -WT	5" ANTI-GLARE LENS				
	ETL28216	-BK, -WT	9" ANTI-GLARE LENS				

SPOT LIGHTS

	ETL21210	-BK, -WTBK, -WT	7W SPOT LIGHT
	ETL21211	-BK, -WT	12W SPOT LIGHT
	ETL21212	-BK, -WT	PUSH-PULL BEAM ADJUSTABLE
	ETL21214	-BK, -114BK, -114WT, -WT	5W SPOT LIGHT







CORNER LIGHTS

	ETL29212	-BK, -WT	90° SINGLE SURFACE
	ETL29222	-BK, -WT	90° WALL-to-CEILING

INDIRECT LIGHTS

	ETL29223	-BK	ROUND WALL WASHER
	ETL29224	-BK	SQUARER WALL WASHER

PENDANTS

	ETL31003	-WTBK	PENDANT
	ETL31006	-WTBK	PENDANT
	ETL31622	-BK, -NAB, -WT	PENDANT
	ETL31022	-BK, -NAB, -WT	PENDANT
	ETL31013	-WT, -WTNAB	PENDANT
	ETL31251	-BK, -NAB, -WT	PENDANT