

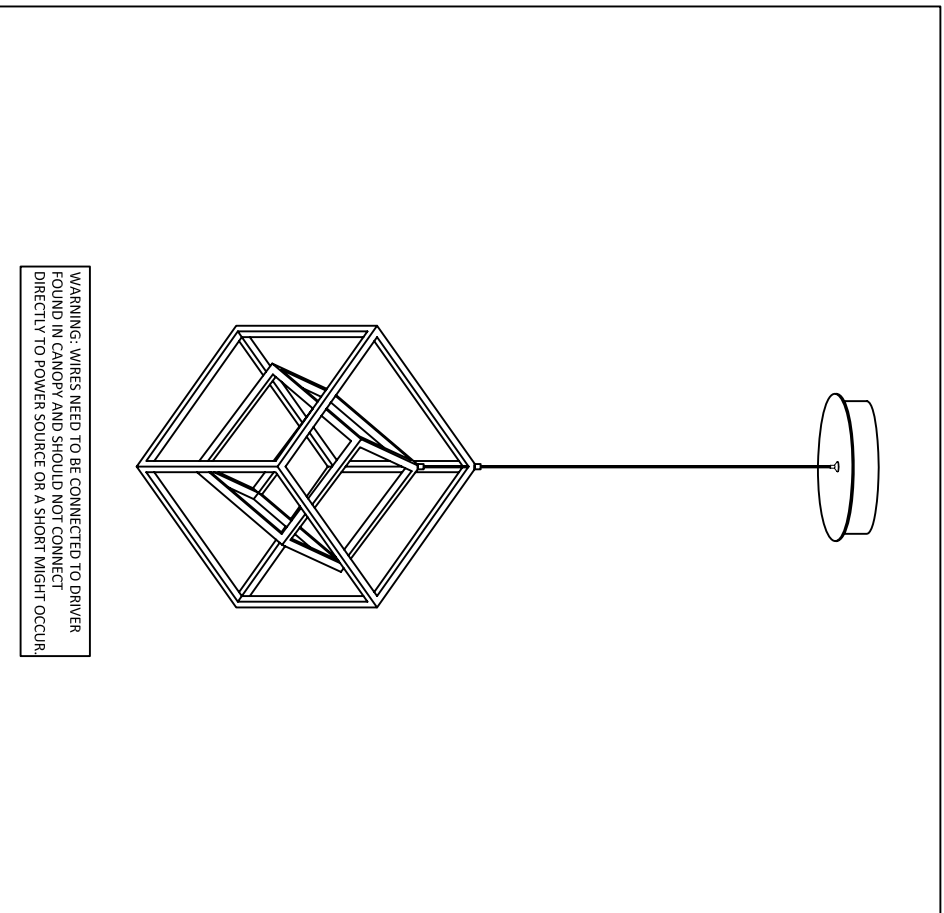

# Contemporary Lighting™

PRODUCT NAME: 4 SQUARE  
ITEM NUMBER: E30584-BKPC

Please consult your electrician for hanging fixture and wiring.



WARNING- WIRES NEED TO BE CONNECTED TO DRIVER FOUND IN CANOPY AND SHOULD NOT CONNECT DIRECTLY TO POWER SOURCE OR A SHORT MIGHT OCCUR

Bulb (integrated): 40 Watts LED

**IMPORTANT:** Turn off the power at the main fuse or circuit breaker box before starting installation

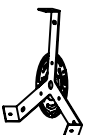

Bracket (A)

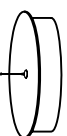

Canopy (B)

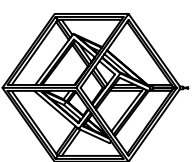

Body (C)

Locate all hardware & components before discarding packaging

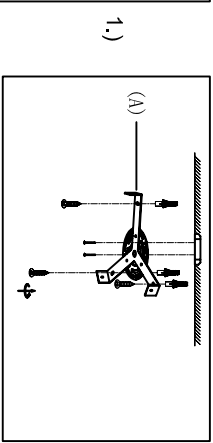
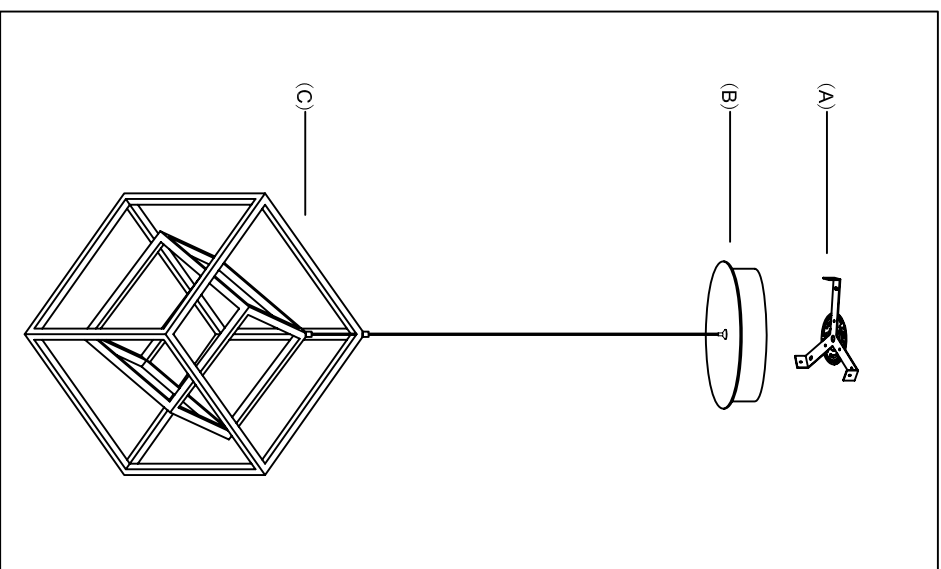

1.)

Step 1: Remove Bracket (A) from fixture and install to electrical box.

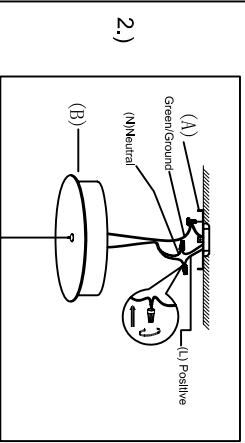

2.)

Step 2: Wire fixture to wires in outlet box. Install Green wire to Ground Screw.

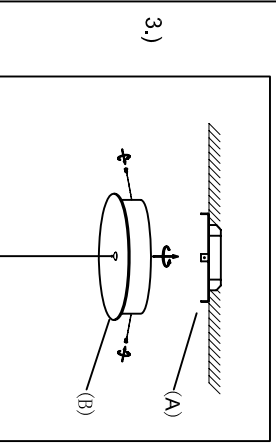

3.)

Step 3: Adjust wire length to desired hanging height. Install Canopy (B) to Bracket (A) and tighten screws at the end of canopy to secure.

**Cleaning & Care:**  
Clean with soft cloth and a mild detergent.  
Do not use abrasive cleaner.