

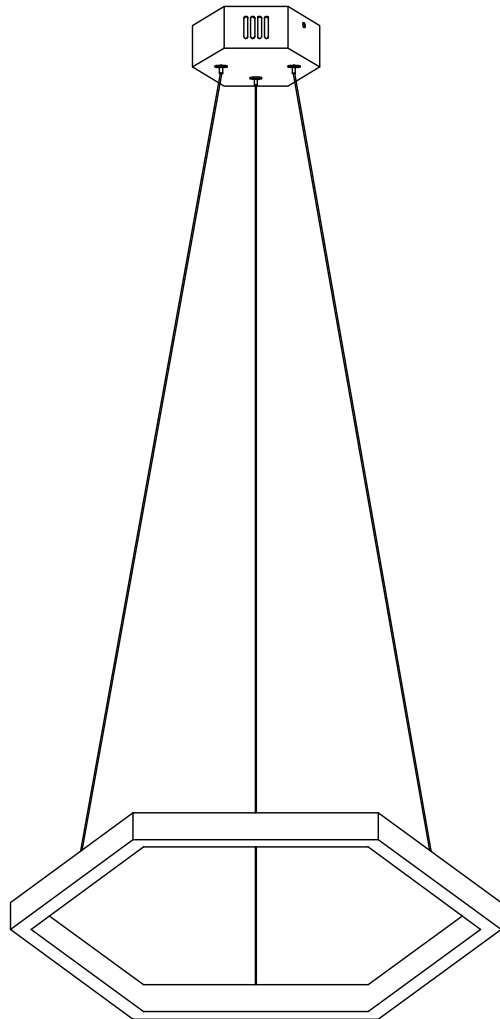

Contemporary  
Lighting™

**PRODUCT NAME:Hex LED Pendant**  
**ITEM NUMBER: E22285**



**WARNING: Wires need to be connected to driver found in canopy and should not be connected directly to power source or a short may occur.**

**The fixture is designed to dim with a standard Triac forward phase dimmer.**

**Dimming levels will vary by dimmer.**

**Below is a list of recommended dimmers:**

**Lutron MACL-153M**

**Lutron DVL-153P**

**Lutron SCL-153P**

**Leviton IPL06-10Z**

**Leviton 6674-POW**

**Due to inrush current wattage should not exceed 150 watts of product for a 600 watt dimmer.**

**Bulbs (integrated): LED 50W**

**IMPORTANT: Turn off the power at the main fuse or circuit breaker box before starting installation**

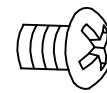
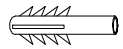

**Screws\*2PCS**

**Bracket**

**Mounting Screws\*2PCS**

**Locate all hardware & components before discarding packaging**

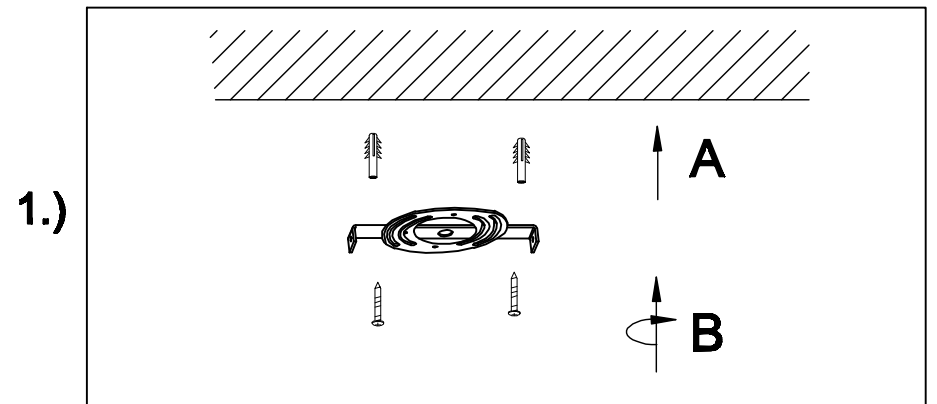
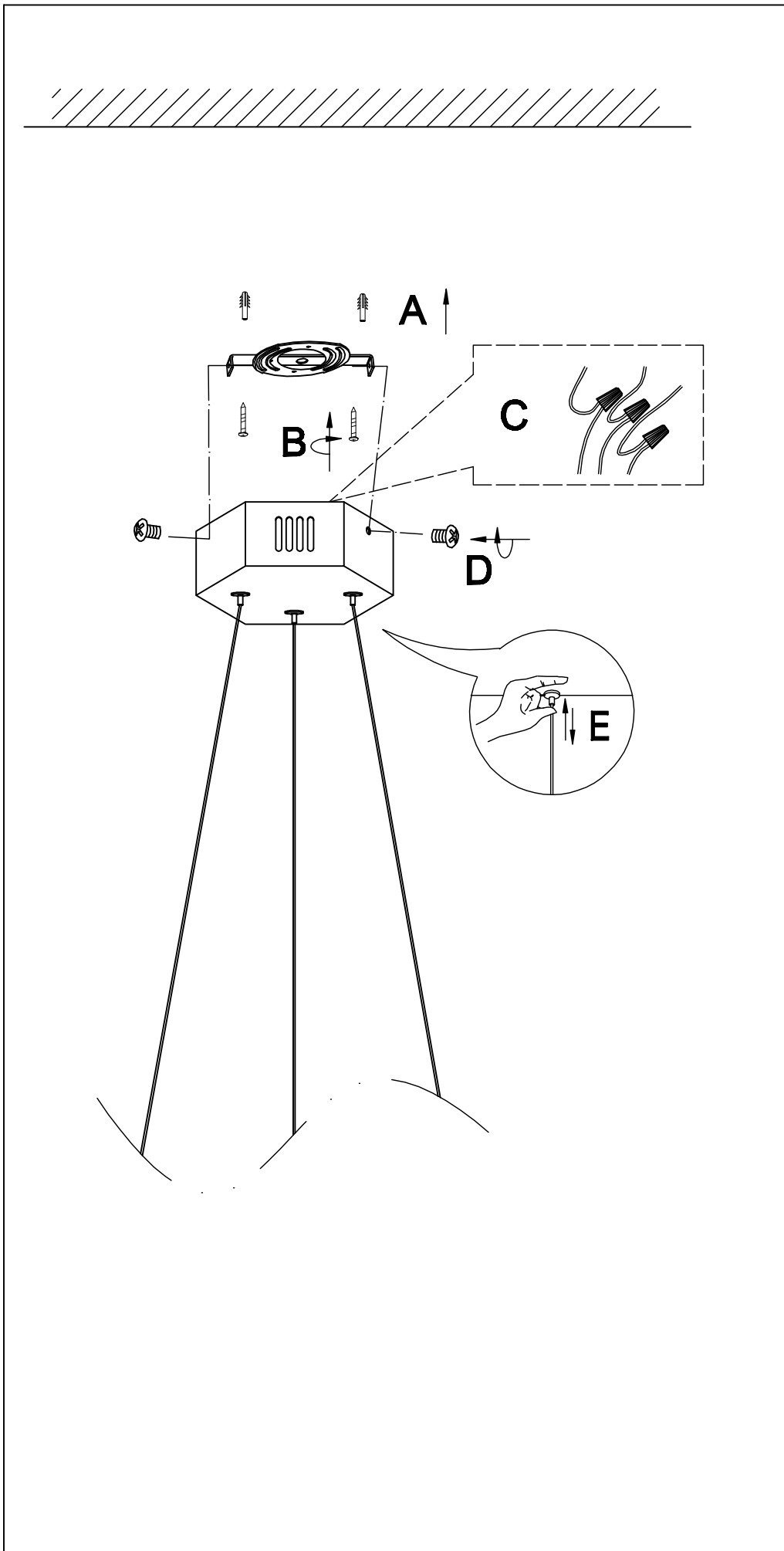

**Step 1: Remove mounting bracket from fixture and install to electrical box.**

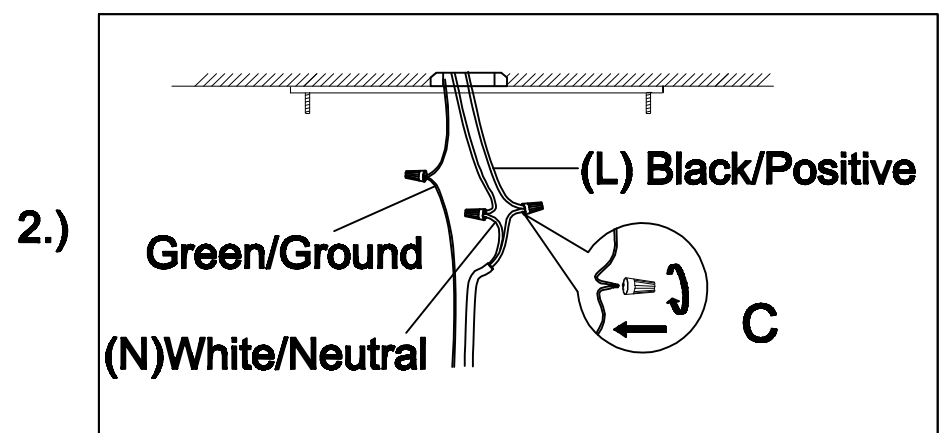

**Step 2: Adjust wires to desired mounting height. Wire fixtures to wire in outlet box. Refer to dual plastic wire instructions to connect low voltage wire to driver.**

**Cleaning & Care:**

**You may use talcum powder and a soft cloth for cleaning. Do not use abrasive cleaner.**

## Low voltage Wires

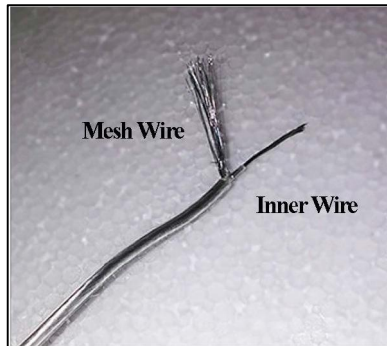

## Driver Wires

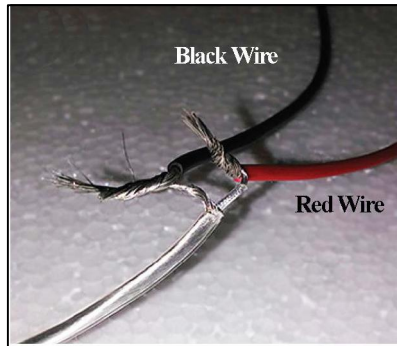

Lamp	Driver
InnerWire (+)	Driver Red (+)
Outer Mesh (-)	Driver Black (-)

**Please note the low voltage wires consist of an outer mesh wire (ground) and inner wire (live) that must be separated before re-joining with the driver output wires. the two drivers are wired in parallel to the low voltage wires, as shown below**

LED-DT24V-20 LED-DT24V-45

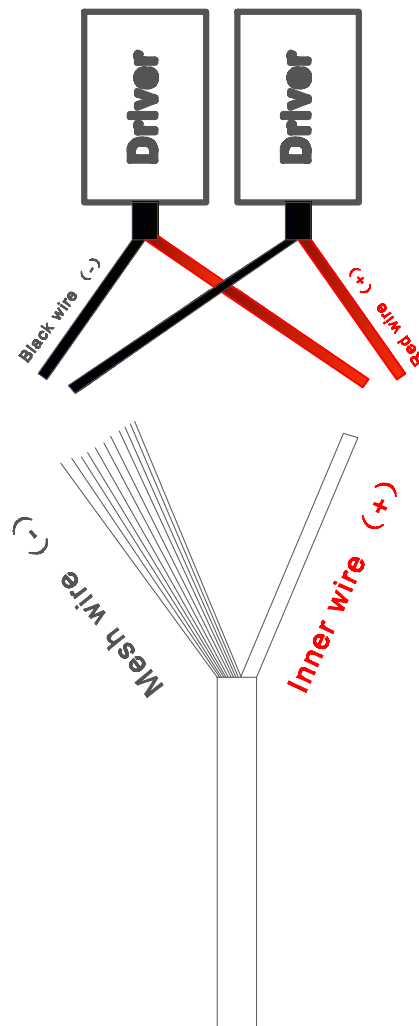

# Dual Plastic Wiring Instructions

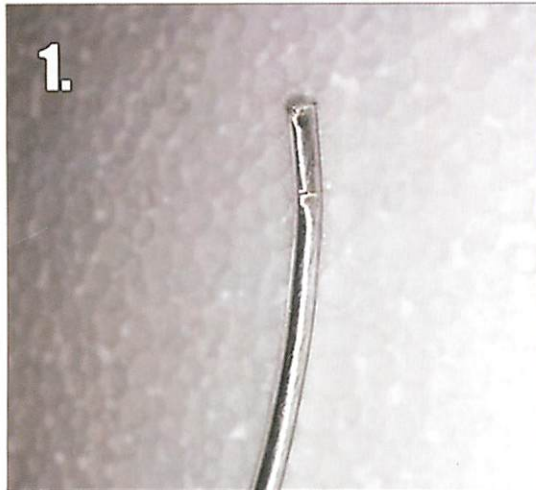

Strip the clear plastic off the pendant electrical wire.



Exposed is the mesh wire and the inner wire.

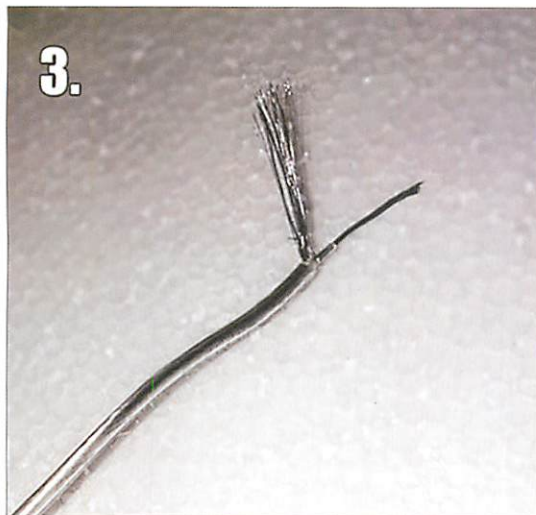

Pull the mesh wire away to isolate the inner wire. The inner wire will also have a plastic coat that needs to be stripped.

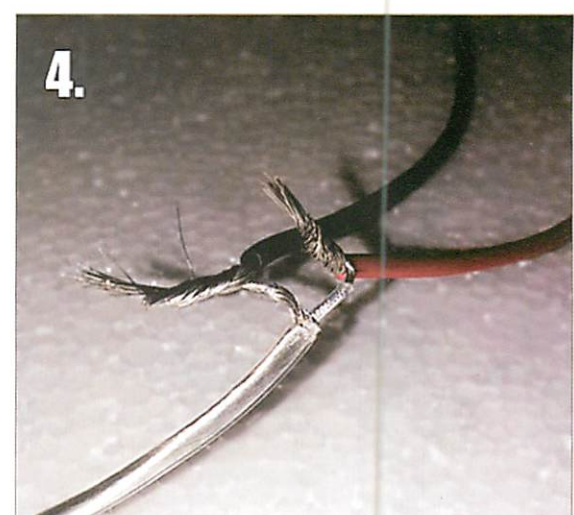

Once the two wires are formed, connect the mesh wire (ground) to the black wire and the inner wire to the red wire (live).