

# Contemporary Lighting™

Item/Model Number: E11076-122

PEBBLE 10-Light LED Pendant

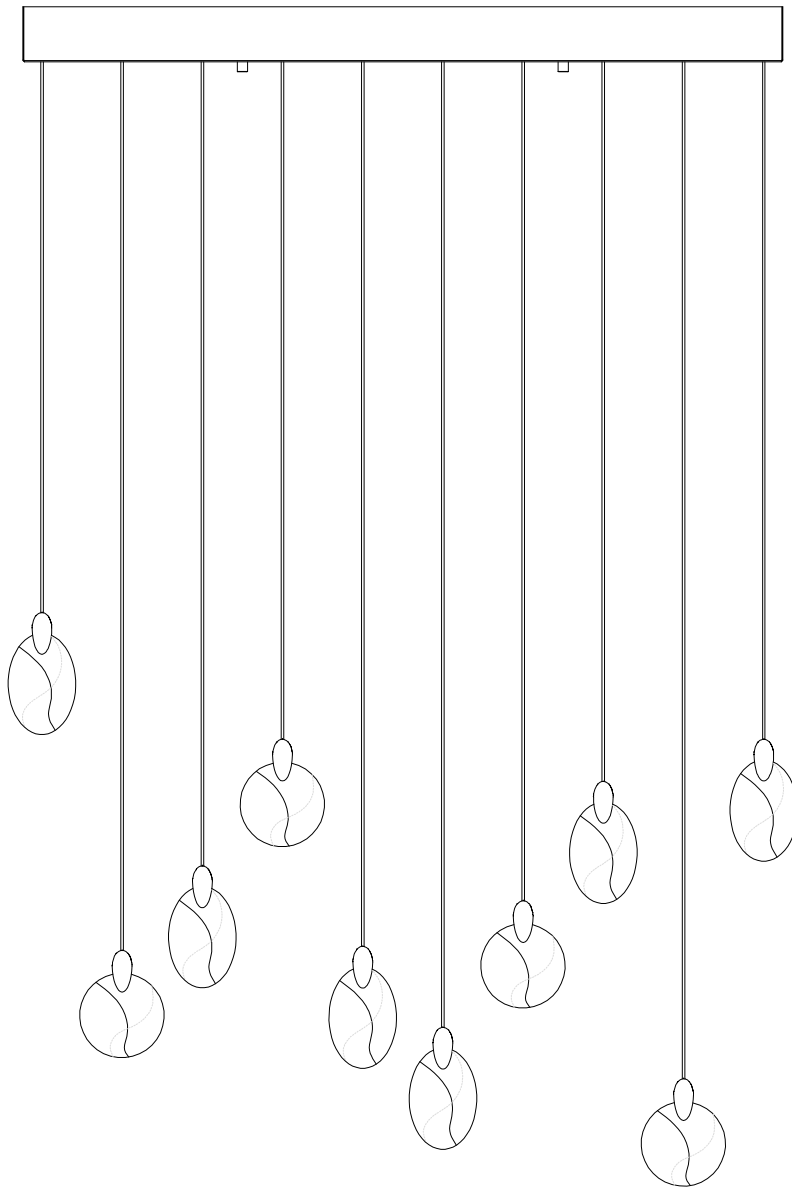







Lamping | Ampoule: 10 x LED 2W + 3 x GU10 LED 7W(Included)

Please consult a qualified electrician prior to install





Veuillez consulter un électricien qualifié pour suspendre le luminaire et le câblage.

Made in China | Fabrique en Chine | Hecho en China

## LED LOW-VOLTAGE INSTRUCTIONS

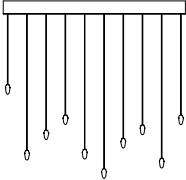
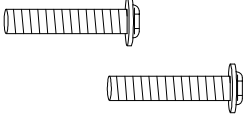
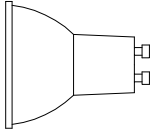
| English <b>Before Getting Started</b>  | Français <b>Avant de Commencer</b>   | Español <b>Antes de Comenzar</b>  |
|--|--|---|
| Read the instructions carefully prior to assembling the product.   | Lire attentivement les instructions avant d'assembler le produit.  | Lea atentamente las instrucciones antes de ensamblar el producto.   |
| When you open the package with a sharp tool like a box knife, be careful not to damage the components inside.  | Lorsque vous ouvrez le paquet avec un outil pointu comme un couteau de coupe, veillez à ne pas endommager les composants à l'intérieur.  | Cuando abra el paquete con una herramienta afilada como un cuchillo de corte, tenga cuidado de no dañar los componentes dentro.   |
| Carefully remove all packaging materials and retain for future use.  | Retirez soigneusement tous les matériaux d'emballage et conservez-les pour un usage ultérieur.   | Retire con cuidado todos los materiales de embalaje y consérvelos para usarlos en el futuro.  |
| Keep all hardware parts and packaging out of reach of children.  | Conservez toutes les pièces matérielles et les emballages hors de portée des petits enfants.   | Mantenga todas las piezas y embalajes de hardware fuera del alcance de los niños pequeños.  |
| Choose a clean, level, spacious assembly area. Avoid hard surfaces that may damage the product.  | Choisissez une zone d'assemblage propre, de niveau et spacieuse. Évitez les surfaces dures qui pourraient endommager le produit.   | Elija una zona de ensamblaje limpia, nivelada y espaciosa. Evite superficies duras que puedan dañar el producto.  |
| Ensure that you have all required contents for complete assembly.  | Assurez-vous que vous avez tous les contenus requis pour l'assemblage complet.   | Asegúrese de que tiene todos los contenidos necesarios para el ensamblaje completo.   |
| Take care when lifting. Assemble the product in close proximity to where you intend to install it.   | Prenez soin de soulever. Assemblez le produit à proximité de l'endroit où vous comptez positionner l'élément.  | Tenga cuidado al levantar. Ensamble el producto cerca de donde tiene la intención de posicionar el artículo.  |
| Do not over tighten the screws and bolts as this may damage the threads.   | Ne serrez pas trop les vis et les boulons car cela pourrait endommager les filets.   | No apriete excesivamente los tornillos y pernos, ya que esto puede dañar los hilos.   |
| Do not let children play with this product.  | Ne laissez pas les enfants jouer avec ce produit.  | No permita que los niños jueguen con este producto.   |
|  <b>Risk of suffocation!</b><br>Keep packaging materials away from children.   |  <b>Risque asphyxiel!</b><br>Tenez tous les matériaux emballage à l'écart des enfants   |  <b>Riesgo de sofocación!</b><br>Mantenga los materiales de emb/alaje lejos de los niños.                                  |
| <b>Lamp Care Instructions</b>  | <b>Entretien de la Lampe</b>   | <b>Instrucciones de Lámparas</b>  |
| Carefully read through the instruction sheet before assembly and using the product.  | Avant de procéder à l'assemblage et à l'utilisation de la lampe, lisez attentivement le mode d'emploi.   | Lea cuidadosamente la hoja de instrucciones (si fue proporcionada) antes de armar y utilizar la lámpara.  |
|  <b>Caution there is a risk of shock!</b><br>Disconnect from power source before assembling or cleaning.                               |  <b>Pour éviter tout risque d'électrocution, débranchez la lampe de la prise électrique avant de procéder à l'assemblage ou au nettoyage de la lampe.</b> |  <b>Peligro por descarga eléctrica.</b> Desconecte la lámpara de la fuente de electricidad antes de armarla o limpiarla. |
| Switch off, unplug and allow bulb to cool before replacing bulb or cleaning.   | Avant de remplacer ou de nettoyer l'ampoule, éteignez et débranchez la lampe.  | Apáguela, desenchúfela y deje que la bombilla se enfríe antes de reemplazarla o limpiarla.  |
| Only <b>use the recommended</b> bulb type and do not exceed the maximum wattage as it could cause fire.  | Afin d'éviter tout risque de feu, utilisez le type et la puissance d'ampoule recommandés.  | Solo utilice el tipo de bombilla recomendado y no exceda la potencia eléctrica máxima ya que puede causar un incendio.  |
| Check the product cord to be sure is free torn or frayed.  | Ne branchez pas la lampe si son cordon d'alimentation est déchiré ou effiloché   | No conecte la lámpara si el cable eléctrico está dañado o deshilachado.   |
|  <b>WARNING:</b> Wires must be connected to low voltage driver and should not be connected directly to live wire or a short may occur. |  <b>AVERTISSEMENT :</b> Les fils doivent être connectés au conducteur et ne doivent pas être connectés directement aux fils sous tension                  |  <b>ADVERTENCIA:</b> Los cables deben estar conectados al controlador y no deben conectarse directamente al cable activo |
| <b>Cleaning &amp; Maintenance</b>  | <b>Nettoyage et Maintenance</b>  | <b>Limpeza y Mantenimiento</b>  |
| On polished finishes, often using talc powder can reduce the appearance of fingerprints and other smudges.   | Sur les finitions polies, souvent en utilisant la poudre de talc réduit l'apparence des empreintes digitales et d'autres taches.   | En acabados pulidos, a menudo usando polvo de talco reduce la aparición de huellas dactilares y otras manchas.  |
| For respective shade surfaces, use the appropriate cleansers, i.e. glass cleaner, stone polish, & wood polish.   | Pour les surfaces d'ombrage respectives, utilisez les nettoyants appropriés, c'est-à-dire le nettoyant pour vitres, vernis à pierre et le vernis à bois.   | Para las respectivas superficies de sombra, utilice los limpiadores apropiados, es decir, limpiador de vidrio, esmalte acrílico y pulido de madera.   |
| Clean with soft cloth and a mild detergent. Do not use abrasive or harsh cleaners.   | Nettoyer avec un chiffon doux et un détergent doux. N'utilisez pas de nettoyant abrasif.   | Utilice un trapo limpio, suave y seco que no raye ni manche la superficie cuando quite el polvo.  |
| Periodically (every 90-180 days) make sure that the screws are fully tightened.  | Périodiquement (tous les 90-180 jours), assurez-vous que les vis sont bien serrées.  | Periódicamente (cada 90-180 días) asegúrese de que los tornillos estén bien apretados.  |
| Prolonged exposure to heat sources may cause glazing, melting and scorching, or even cause color to fade.  | Si le tissu subit une exposition prolongée aux sources de chaleur, il pourrait commencer à reluire, à roussir, à s'estomper ou même à se décolorer.  | La exposición prolongada a las fuentes de calor causa cristalización, derretimiento, quemadura y decoloración del tapizado.   |

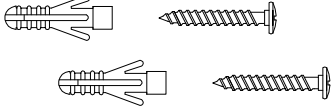
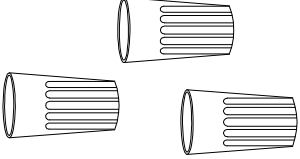
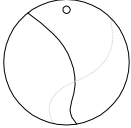
|  |  |   |
|--|--|---|
| <p><b>English PARTS</b></p>  | <p><b>Français PIÈCES</b></p>  | <p><b>Espanol PARTES</b></p>  |
| <p>Before getting started, ensure the package contains the following components:</p> | <p>Antes de comenzar, asegúrese de que el paquete contenga los siguientes componentes:</p> | <p>Avant de commencer, assurez-vous qu'il y a le paquet contient les composants suivants:</p> |

|                 |  |           |                 |  |           |
|-----------------|--|-----------|-----------------|--|-----------|
| <p><b>A</b></p> |                                       | <p>x1</p> | <p><b>H</b></p> | <p>NE032120YYY-2G</p> <div style="border: 1px solid black; padding: 5px; width: fit-content; margin: 0 auto;"> <p><b>LED CC DRIVER</b><br/>120V   18-40V 700ma</p> </div> <p>3.25"x1.5"x1"</p> | <p>x1</p> |
| <p><b>B</b></p> |  <p>#8-32x1.25"</p>                   | <p>x2</p> | <p><b>I</b></p> |  <p>GU10 LED 120V 7W<br/>BL7GU10CL120V30(Included)</p>  | <p>x3</p> |
| <p><b>C</b></p> |                                       | <p>x2</p> | <p><b>J</b></p> |  <p>#9-40x1"</p>  | <p>x4</p> |
| <p><b>D</b></p> |                                     | <p>x3</p> | <p><b>K</b></p> |  |           |
| <p><b>E</b></p> |  <p>GLS 4x4"<br/>BL8233D100U100</p> | <p>x4</p> | <p><b>L</b></p> |  |           |
| <p><b>F</b></p> |  <p>GLS 3x5"<br/>BL8233D120U80</p>  | <p>x6</p> | <p><b>M</b></p> |  |           |
| <p><b>G</b></p> |                                     | <p>x1</p> | <p><b>N</b></p> |  |           |

This fixture is equipped with an LED driver, please refer to the **Wiring Diagram** for more details  
Ce luminaire est équipé d'un pilote a LED, veuillez vous référer au **Schéma De Câblage** pour plus de détails  
Este accesorio está equipado con un controlador LED, por favor consulte el **Diagrama De Cableado** para obtener más detalles.

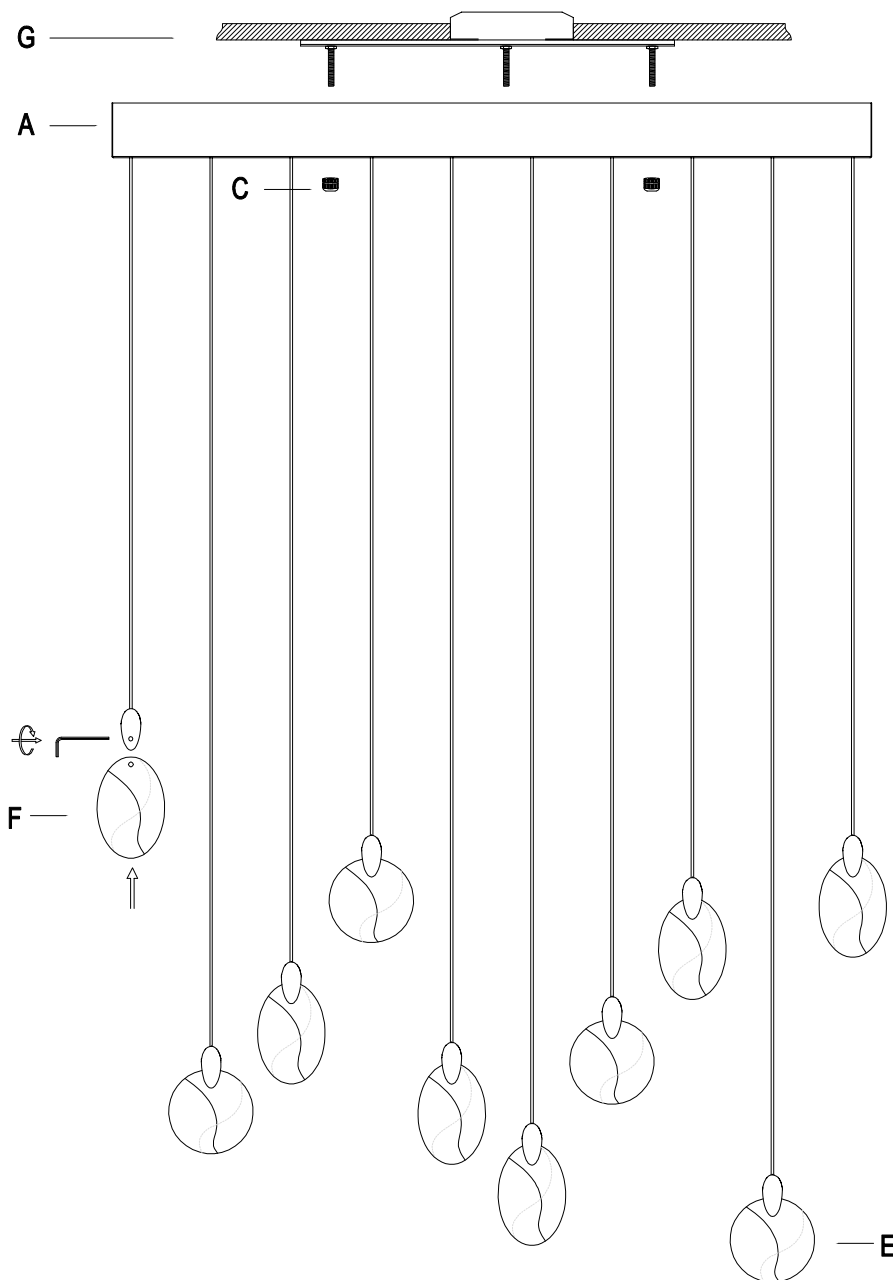
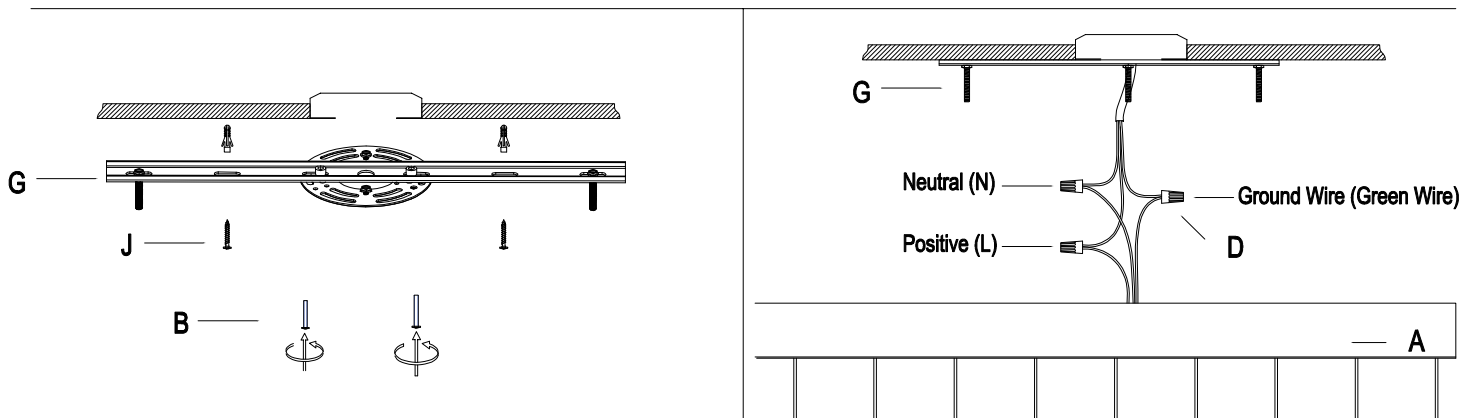

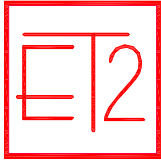

ITEM/MODEL: E11076-122

MUST be installed by an experienced professional  
CRITICAL KNOWLEDGE of electronic lighting systems required

IMPROPER WIRING and/or INCORRECT DIMMER use can cause CATASTROPHIC DAMAGE!

THIS FIXTURE MUST BE INSTALLED with a COMPATIBLE DIMMER SWITCH

DO NOT CUT FACTORY-MADE CONNECTIONS.

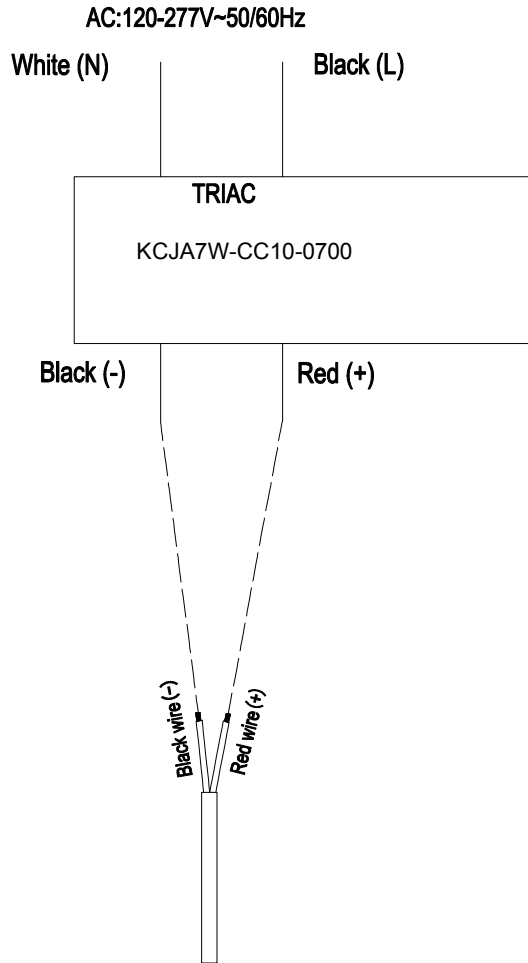

**FACTORY CONNECTIONS**  
(+) INNER CONDUCTOR | OUTER MESH(-)

LED DRIVER DIAGRAM

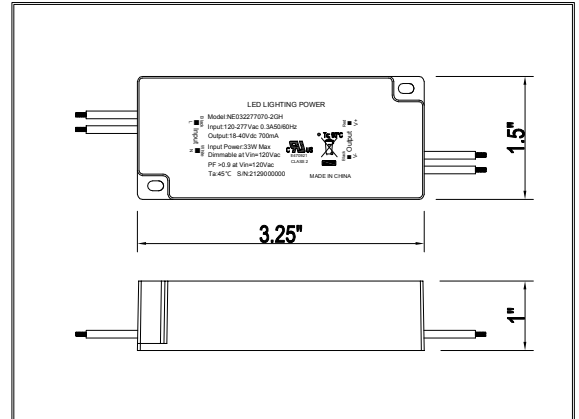

SCHEMATIC  
FOR GENERAL  
REFERENCE ONLY

VERIFIED LIST OF TESTED DIMMERS

- Lutron Diva DVCL-153P
- Lutron Diva DVELV-300P
- Lutron Diva Caseta PD-6WCL
- Lutron Maestro MACL-153M
- DEAKO-Smart Dimmer
- DEAKO-Single Dimmer
- LEVITON 6672-L
- LEVITON DSL06

GENERAL COMPATIBILITY

**TRIAC / FORWARD PHASE  
ELV / REVERSE PHASE**

**Only at 120VAC  
0-10V/ LOW VOLTAGE**

**Work at 120-277VAC**

Due to inrush current, wattage should not exceed 150W on a 600W dimmer

IMPORTANT!

If the control is not paired properly to LED fixtures, irreparable damage may occur.

If the dimmer you are using is not listed here, consult a lighting professional or view our Dimming Compatibility Chart online:

[www.et2online.com/led-dimmer](http://www.et2online.com/led-dimmer)

MUST be installed by an experienced professional  
CRITICAL KNOWLEDGE of electronic lighting systems required