

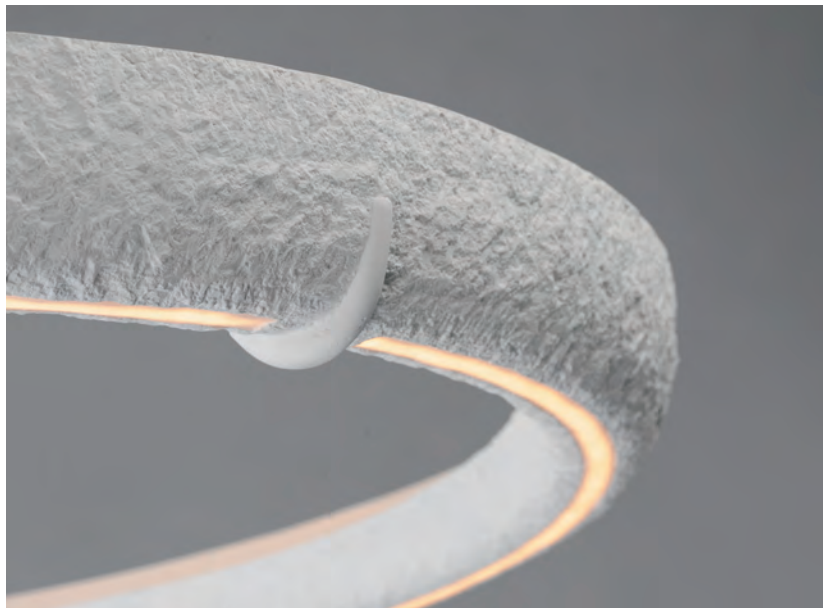

JANUARY 2025 INTROS

# GEIST

Inspired by early 20<sup>th</sup> century plaster works, the Geist collection features a modern integration of LED lighting in a plaster crafted ring with both indirect uplighting and functional downlighting.



# GEIST

- Crafted out of plaster
- Indirect and direct light



SCULPTED  
PLASTER

**E25193-TW**  
Pendant

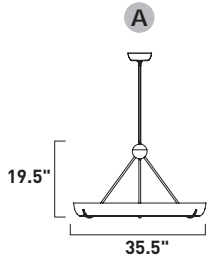

**E25194-TW**  
Pendant

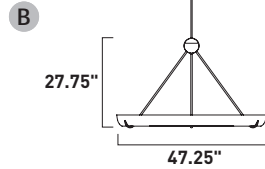

	ITEM #	FINISH	LAMPING	DIMENSION	LUMENS			Additional Information
					CRI	INIT.	DEL.	
A	E25193	TW	54W PCB LED 3000K (Inte.)	35.5"L x 35.5"W x 19.5"H, 64" OAH	90+	4320	3000	LED 3000K 1
B	E25194	TW	75W PCB LED 3000K (Inte.)	47.25"L x 47.25"W x 27.75"H, 72" OAH	90+	6000	4250	LED 3000K 1

Finish: Textured White (TW)



# NIMBUS

Oblong glass globe shades feature a intriguing Marble swirl pattern that obscures the integrated LED lighting within. Thin black electrical cords are easily adjustable. A larger oval 8-Light configuration features multiple sizes of the glass to create an interpretative congregation of clouds. Also available as a 3-Light, 5-Light and single pendant.





# NIMBUS

- Swirling Marble glass
- LED 3000K Color Temperature
- Matte Black frame and cord
- 3 varied sizes of glass shades



E11529-113BK  
Pendant

A

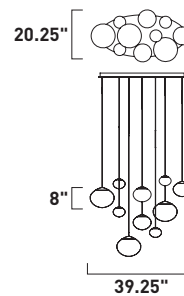

ITEM #	FINISH	LAMPING	DIMENSION	LUMENS			Additional Information
				CRI	INIT.	DEL.	
A E11529	113BK	10 x 7.5W PCB LED 3000K (Inte.)	39.25"L x 20.25"W x 8"H, 129.5" OAH	90+	5000	4800	LED 3000K ⓘ

Finish: Marble Swirl glass (113) Black (BK)

# NIMBUS



- Swirling Marble glass
- LED 3000K Color Temperature
- Matte Black frame and cord
- 3 varied sizes of glass shades

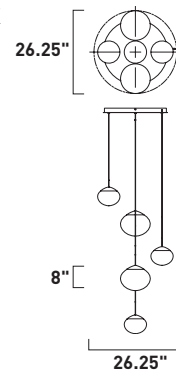

**E11525-113BK**  
Pendant

**A**



ITEM #	FINISH	LAMPING	DIMENSION	LUMENS			Additional Information
				CRI	INIT.	DEL.	
A E11525	113BK	5 x 7W PCB LED 3000K (Inte.)	26.25"L x 26.25"W x 8"H, 127.5" OAH	90+	3400	2800	  

Finish: Marble Swirl glass (113) Black (BK)



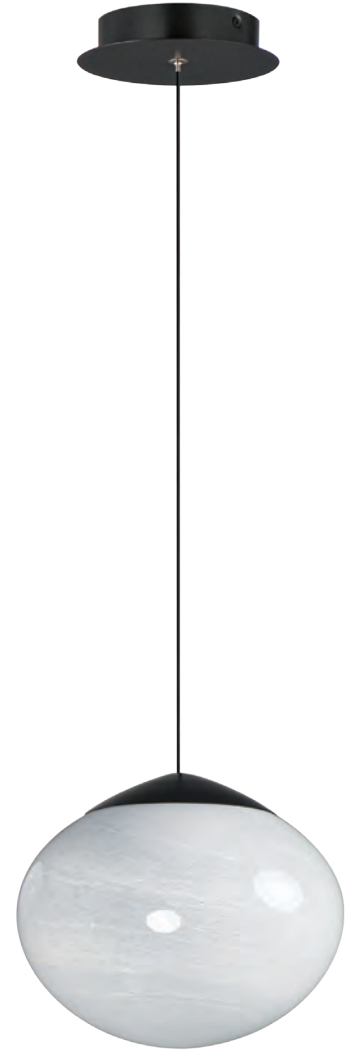

**E11523-113BK**  
Pendant  
**B**

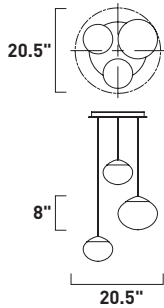

**E11521-113BK**  
Pendant  
**C**

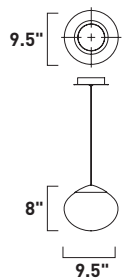

	ITEM #	FINISH	LAMPING	DIMENSION	LUMENS			Additional Information
					CRI	INIT.	DEL.	
<b>B</b>	E11523	113BK	3 x 7W PCB LED 3000K (Inte.)	20.5"L x 20.5"W x 8"H, 127.25"OAH	90+	2000	1680	LED DIM ↑
<b>C</b>	E11521	113BK	1 x 9W PCB LED 3000K (Inte.)	9.5"L x 9.5"W x 8"H, 129.25"OAH	90+	880	720	LED DIM ↑

Finish: Marble Swirl glass (113) Black (BK)

# SOLEIL

Sweeping matte white acrylic tubes encase an omnidirectional LED light source, arranged in abstract configurations inspired by solar flares. Minimal in composition yet dramatic in form, the Soleil collection offers a striking lighting solution. Available in a range of sizes, including fixed flush mount and field-adjustable pendant configurations, Soleil is offered in Polished Chrome, Matte Black, and Natural Aged Brass, making it a perfect complement to a variety of interior color schemes.

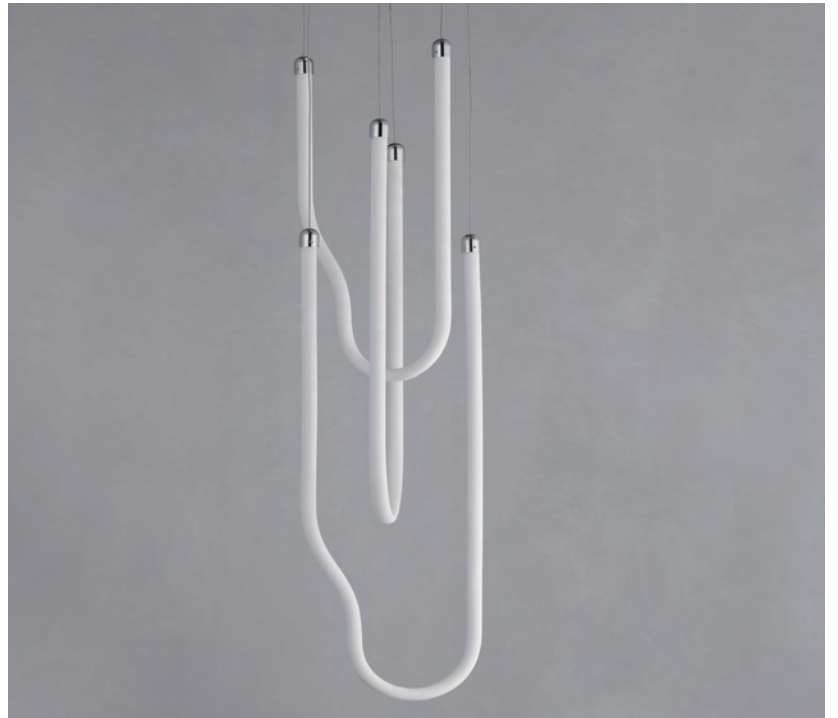



- Abstract configurations of matte white acrylic tubes evoke the dynamic beauty of solar flares.
- Omnidirectional LED integrated light source
- Offered in fixed flush mount configurations and field-adjustable pendant
- Available in Polished Chrome, Matte Black, and Natural Aged Brass finishes to complement diverse interior styles.



**E24989-BK, -NAB, -PC**  
Flush Mount

**A**

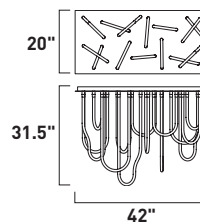

ITEM #	FINISH	LAMPING	DIMENSION	LUMENS			Additional Information
				CRI	INIT.	DEL.	
<b>A</b> E24989	BK, NAB, PC	130W PCB LED 3000K (Inte.)	42"L x 20"W x 31.5"H	90+	10400	6100	

Finish Options: Black (BK) Natural Aged Brass (NAB) Polished Chrome (PC)

# SOLEIL

- Abstract configurations of matte white acrylic tubes evoke the dynamic beauty of solar flares.
- Omnidirectional LED integrated light source
- Offered in fixed flush mount configurations and field-adjustable pendant
- Available in Polished Chrome, Matte Black, and Natural Aged Brass finishes to complement diverse interior styles.



**E24988-BK, -NAB, -PC**

Pendant

**A**

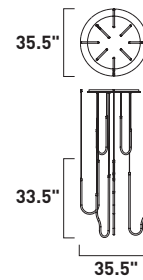

ITEM #	FINISH	LAMPING	DIMENSION	LUMENS			Additional Information	
				CRI	INIT.	DEL.		
A	E24988	BK, NAB, PC	110W PCB LED 3000K (Inte.)	35.5" L x 35.5" W x 33.5" H, 155.5" OAH	90+	8800	5200	

Finish Options: Black (BK) Natural Aged Brass (NAB) Polished Chrome (PC)

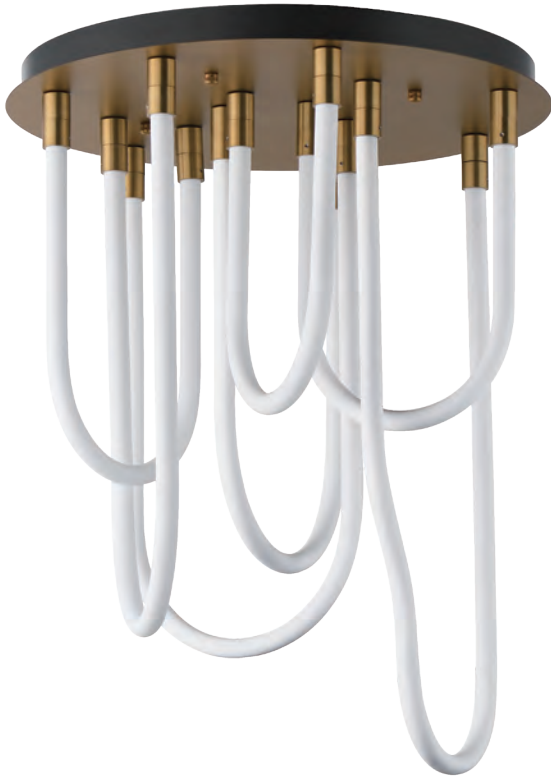

**E24987-BK, -NAB, -PC**  
Flush Mount

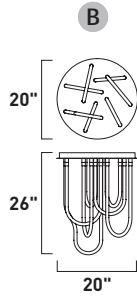

**E24983-BK, -NAB, -PC**  
Pendant

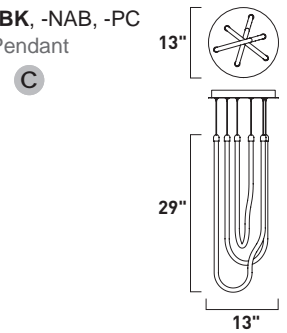

	ITEM #	FINISH	LAMPING	DIMENSION	LUMENS			Additional Information
					CRI	INIT.	DEL.	
<b>B</b>	E24987	BK, NAB, PC	70W PCB LED 3000K (Inte.)	20"L x 20"W x 26"H	90+	5600	3300	LED, DIM
<b>C</b>	E24983	BK, NAB, PC	45W PCB LED 3000K (Inte.)	13"L x 13"W x 29"H, 151" OAH	90+	3000	2700	LED, DIM, ⓘ

Finish Options: Black (BK) Natural Aged Brass (NAB) Polished Chrome (PC)

# PEBBLE

As if naturally formed from the ebbing shores of a riverbed, smooth and irregularly shaped crystal pebbles are suspended by cast metal clasps in a Polished Gold finish. Discreetly illuminated by concealed LED light sources within the clasps, additional downlight originates from LED GU10 lamps housed in a Matte Black canopy adding to the refracting iridescent shimmer on the crystal surface below. Available in multiple configurations of pendants as well as sconce options.





# PEBBLE

- Smooth, irregularly shaped Clear crystal
- Cast metal clasps in plated Gold finish
- Matte Black Canopy
- LED Integrated, 3000K Color Temperature
- Additional LED GU10 lamps included
- Dimmable with ELV and Triac dimmers



**E11070-122BKPG**  
Pendant



**E11071-122BKPG**  
Pendant

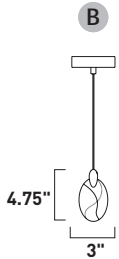

**E11072-122BKPG**  
Wall Mount

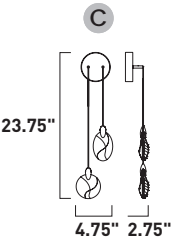

ITEM #	FINISH	LAMPING	DIMENSION	HCO	CRI	LUMENS INIT.	DEL.	Additional Information	
A	E11070	122BKPG	30 x 1W PCB LED 4000K + 5 x 7W GU10 LED 3000K(Inte.)	36" L x 36" W x 4.75" H, 185" OAH	90+	3000	2400	LED, DALI, 0-10V, UL	
B	E11071	122BKPG	1W PCB LED 4000K (Inte.)	3" L x 1.5" W x 4.75" H, 125" OAH	90+	100	80	LED, DALI, 0-10V, UL	
C	E11072	122BKPG	2 x 1W PCB LED 4000K (Inte.)	4.75" W x 23.75" H x 2.75" Ext.	2.25"	90+	200	160	LED, DALI, 0-10V, UL, ADA

Finish: Clear Crystal (122) Black/Polished Gold (BKPG)

# PEBBLE

- Smooth, irregularly shaped Clear crystal
- Cast metal clasps in plated Gold finish
- Matte Black Canopy
- LED Integrated, 3000K Color Temperature
- Additional LED GU10 lamps included
- Dimmable with ELV and Triac dimmers



**E11079-122BKPG**  
Pendant  
**A**

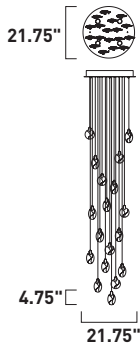

**E11078-122BKPG**  
Pendant  
**B**

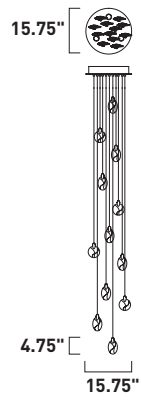

	ITEM #	FINISH	LAMPING	DIMENSION	LUMENS			Additional Information
					CRI	INIT.	DEL.	
A	E11079	122BKPG	18 x 1W PCB LED 4000K + 4 x 7W GU10 LED 3000K(Inte.)	21.75" L x 21.75" W x 4.75" H, 185" OAH	90+	3330	3050	
B	E11078	122BKPG	12 x 1W PCB LED 4000K + 3 x 7W GU10 LED 3000K(Inte.)	15.75" L x 15.75" W x 4.75" H, 125" OAH	90+	2370	2250	

Finish: Clear Crystal (122) Black/Polished Gold (BKPG)



**E11073-122BKPG**

Pendant

**C**

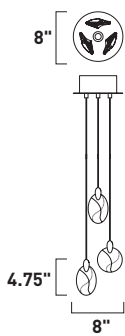

**E11076-122BKPG**

Pendant

**D**

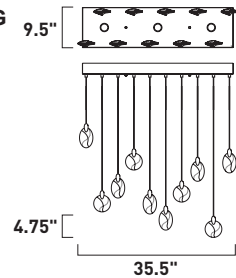

	ITEM #	FINISH	LAMPING	DIMENSION	LUMENS			Additional Information
					CRI	INIT.	DEL.	
C	E11073	122BKPG	3 x 1W PCB LED 4000K + 1 x 7W GU10 LED 3000K(Inte.)	8"L x 8"W x 4.75"H, 125" OAH	90+	690	650	LED 3400lm ↑
D	E11076	122BKPG	10 x 1W PCB LED 4000K + 3 x 7W GU10 LED 3000K(Inte.)	35.5"L x 9.5"W x 4.75"H, 125" OAH	90+	1250	1150	LED 3400lm ↑

Finish: Clear Crystal (122) Black/Polished Gold (BKPG)

# GLOBAL

An airy configuration of Clear blown glass globe shades in various sizes suspend on thin low voltage wires. Thin tubes finished in Black or Gold descend into the center of the globes where a small G4 LED lamp provides a spark of light.



E25077-18BK, -18NAB  
Pendant

A

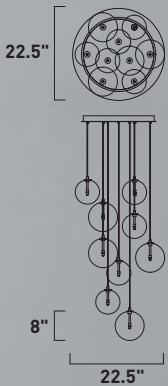



- Clear Glass Globes
- Available in Matte Black or Gold
- 12V low-voltage LED G4 lamps included
- 120-277V Range Voltage Input
- 3-in-1 universal dimming: Triac/ELV at 120V or 0-10V dimming

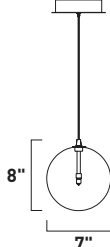
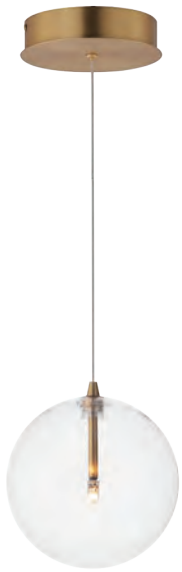
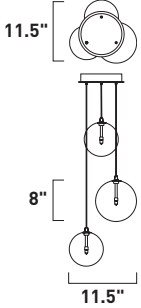

**E25071-18BK, -18NAB**  
Pendant

**C**

**E25073-18BK, -18NAB**  
Pendant

**B**



**E25079-18BK, -18NAB**  
Pendant

**D**

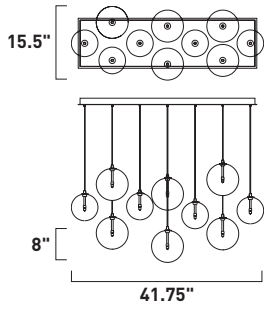

ITEM #	FINISH	LAMPING	DIMENSION	LUMENS			Additional Information
				CRI	INIT.	DEL.	
A	E25077 18BK, 18NAB	9 x 1.8W G4 LED 3000K (Incl.)	22.5" L x 22.5" W x 8" H, 129.5" OAH	90+	1620	1580	LED 3000K 120V
B	E25073 18BK, 18NAB	3 x 1.8W G4 LED 3000K (Incl.)	11.5" L x 11.5" W x 8" H, 141.75" OAH	90+	540	520	LED 3000K 120V
C	E25071 18BK, 18NAB	1 x 1.8W G4 LED 3000K (Incl.)	7" L x 7" W x 8" H, 130" OAH	90+	180	170	LED 3000K 120V
D	E25079 18BK, 18NAB	10 x 1.8W G4 LED 3000K (Incl.)	41.75" L x 15.5" W x 8" H, 137" OAH	90+	1800	1700	LED 3000K 120V

Finish: Clear glass (18) Black (BK) Natural Aged Brass (NAB)



# JENSEN

A tapered, ribbed glass shade adds a contemporary edge to a simple design. Available in Clear Ribbed glass with a plated Gold frame or in Emerald Green or Smoked glass with Matte Black frames. These retro-futuristic shades minimize peripheral glare, while a Matte White acrylic shallow domed diffuser softly disperses LED lighting, delivering ample illumination. The collection includes versatile pendant and flush mount options, with the latter doubling as a wall sconce.

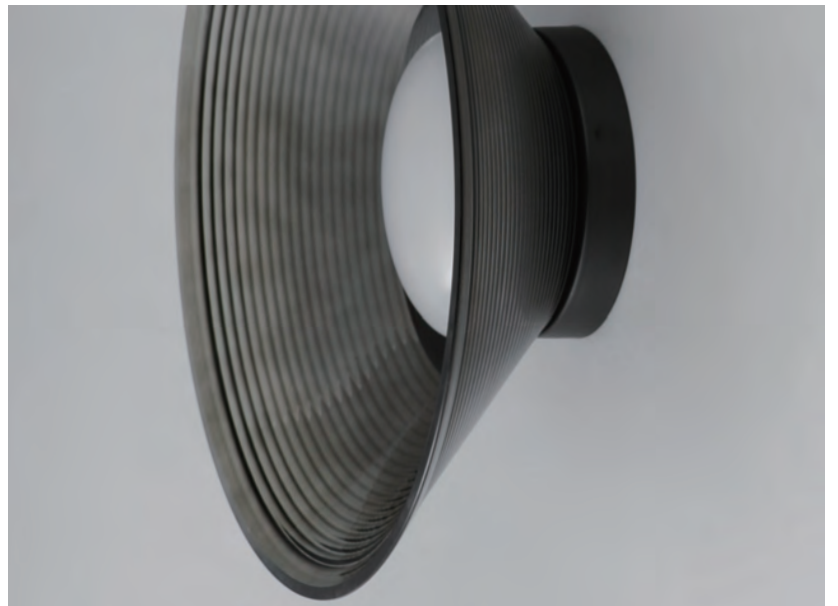

- Tapered and ribbed pressed glass shade
- Vibrant Green, Moody Grey Smoke, or Clear Glass options
- Available in plated Gold or Matte Black finished
- LED 3000K Color Temperature
- ADA Compliant Sconce that can be mounted on the ceiling

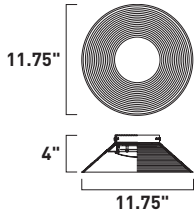

**E22082-04BK, -138BK, -144SBR**  
Wall Mount/Flush Mount

**A**



• Wall Mounted



**E22088-04BK, -138BK, -144SBR**  
Pendant

**B**

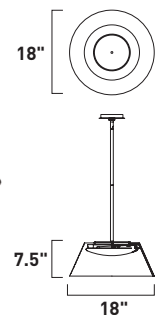

ITEM #	FINISH	LAMPING	DIMENSION	LUMENS			Additional Information
				CRI	INIT.	DEL.	
A	E22082 : 04BK, 138BK, 144SBR	21W PCB LED 3000K (Inte.)	11.75" L x 11.75" W x 4" H	90+	1610	900	LED, DIM, ADA, UL
B	E22088 : 04BK, 138BK, 144SBR	28W PCB LED 3000K (Inte.)	18" L x 18" W x 7.5" H, 52.75" OAH	90+	3900	2000	LED, DIM, ADA, UL

Finish Options: Vibrant Green glass (04) Smoke glass (138) Clear Ribbed glass (144) Black (BK) Satin Brass (SBR)



# WIMBLEDON

Balancing work and play, the Wimbeldon collection is a fun collection of lighting fixtures that utilizes dual-layered sound dampening felt shades that enhance the acoustics of a space. The deep ridged pattern gracefully intersects elevating the simple forms. Choose from linear or half dome configurations in various colors: Dark Grey and Light Cream felts offer more neutral tones while the Olive exterior with Black felt interior presents a more colorful option. Housed within the shades are high powered LED modules that provide ample functional down lighting.

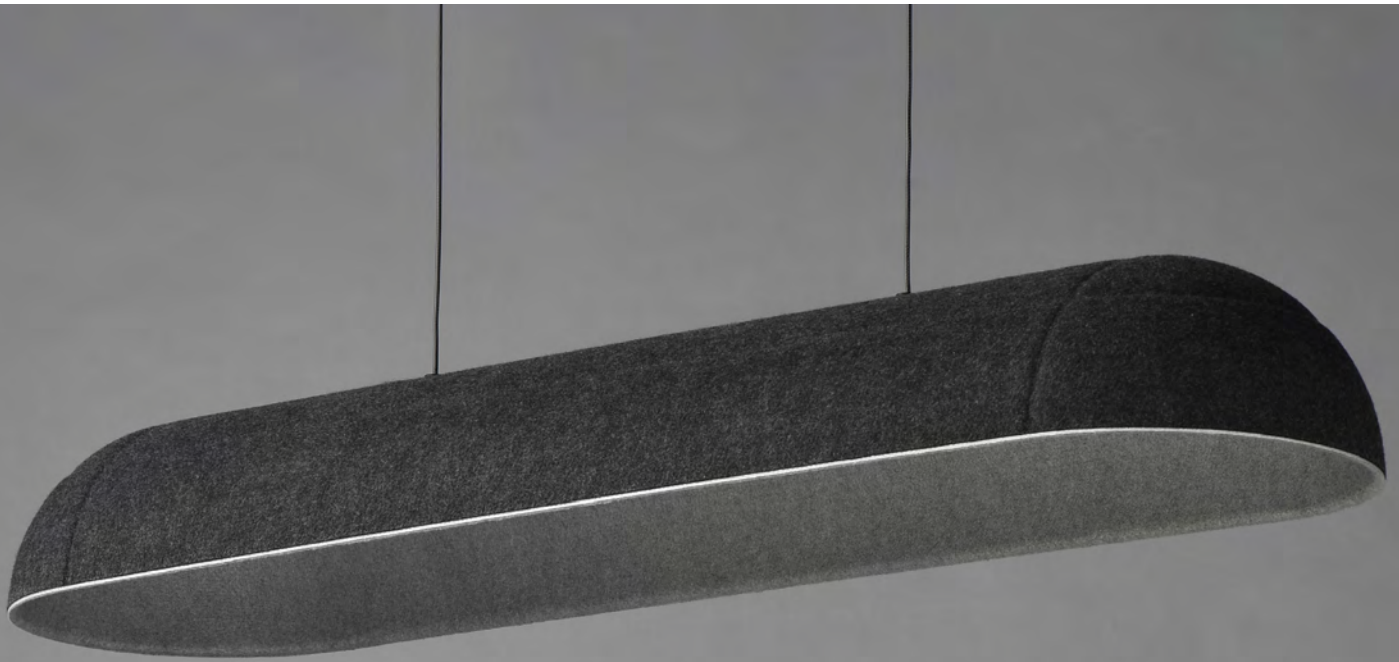



# WIMBLEDON

- Acoustic Felt fabric shades with deep ridge pattern
- Available in Grey, Olive, or Light Cream felt shades
- LED 3000K Color Temperature

**E34614-DG, -LC, -OLV**  
Pendant

**A**

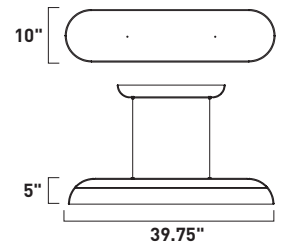
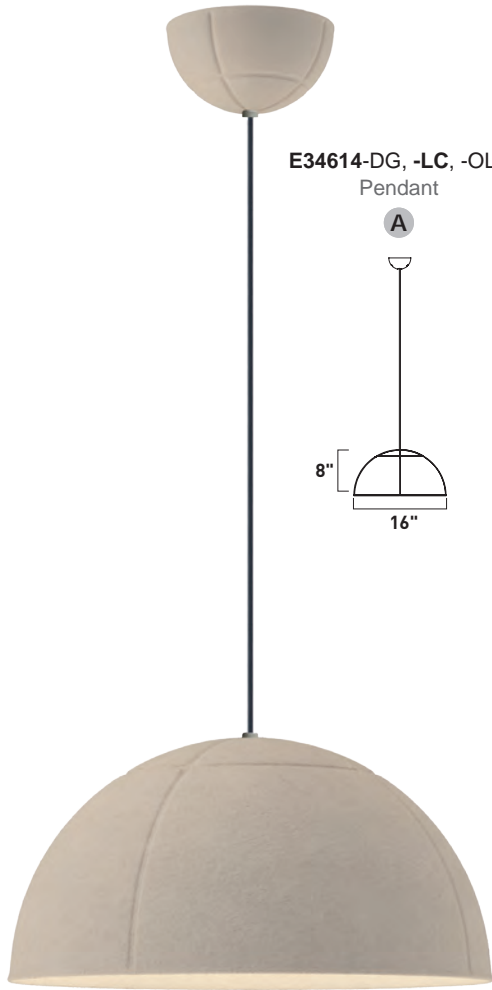
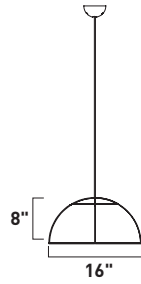

NOISE DAMPENING  
FELT

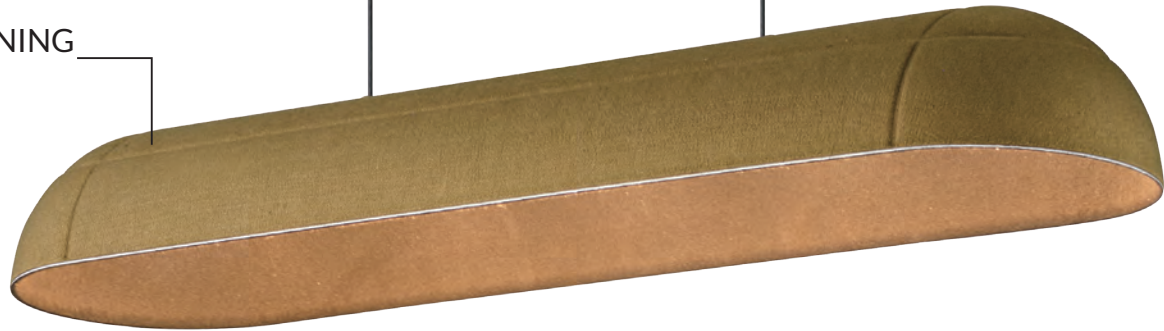

**E34616-DG, -LC, -OLV**  
Linear Pendant

**B**

	ITEM #	FINISH	LAMPING	DIMENSION	LUMENS	CRI	INIT.	DEL.	Additional Information
<b>A</b>	E34614	DG, LC, OLV	12W PCB LED 3000K (Inte.)	16"L x 16"W x 8"H, 132.5"OAH	90+	800	560		
<b>B</b>	E34616	DG, LC, OLV	25W PCB LED 3000K (Inte.)	39.75"L x 10"W x 5"H, 129.75"OAH	90+	1550	1000		

Finish Options: Dark Gray shade (DG) Light Cream shade (LC) Olive shade (OLV)



# ARAGON

Featuring carved Spanish Alabaster shades in sleek cylindrical forms, the Aragon collection conceals high-powered LED light sources within, providing both beauty and functionality. The natural alabaster is elegantly complemented by plated Gold accents, adding an upscale, luxurious touch. Available as pendants or sconces, these fixtures are damp rated, making them ideal for interior spaces including bathrooms



# ARAGON

- Spanish Alabaster shades in sleek cylindrical forms
- LED integrated 3000K
- 120-277V Input
- 3-in-1 dimming: Triac/ELV/0-10V
- Plated Matte Gold finish
- Damp-Rated

SPANISH ALABASTER



**E11202-WAGLD**  
Pendant

**A**

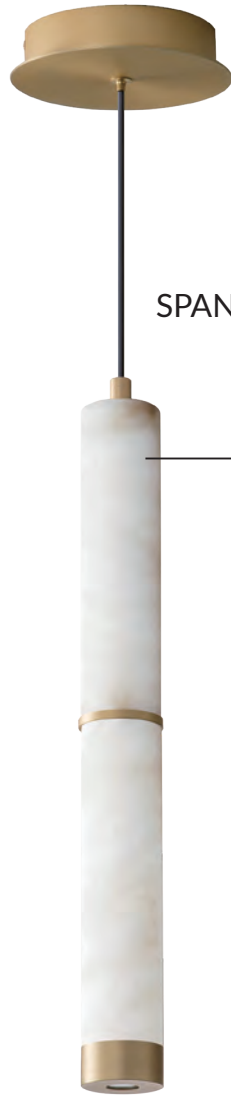
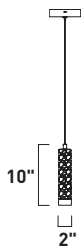

**E11204-WAGLD**  
Pendant

**B**

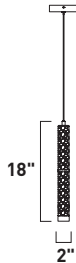

**E11201-WAGLD**  
Bath Vanity

**C**

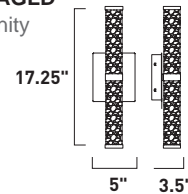

**E11203-WAGLD**  
Bath Vanity

**D**

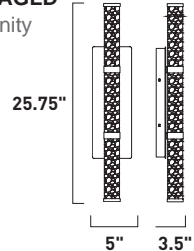

ITEM #	FINISH	LAMPING	DIMENSION	HCO	CRI	LUMENS		Additional Information	
						INIT.	DEL.		
A	E11202	WAGLD	1 x 12W PCB LED 3000K (Inte.)	2"L x 2"W x 10"H, 131.5" OAH		90+	1200	600	LED, DIM, Y
B	E11204	WAGLD	2 x 9.5W PCB LED 3000K (Inte.)	2"L x 2"W x 18"H, 140" OAH		90+	1900	1000	LED, DIM, Y
C	E11201	WAGLD	2 x 9W PCB LED 3000K (Inte.)	5"W x 17.25"H x 3.5" Ext.	8.5"	90+	1800	900	LED, DIM, Y, Z, +
D	E11203	WAGLD	3 x 9W PCB LED 3000K (Inte.)	5"W x 25.75"H x 3.5" Ext.	12.5"	90+	2700	1500	LED, DIM, Y, Z, +

Finish: White Alabaster (WA) Gold (GLD)



# SOJI

Inspired by Japanese lanterns, this soft contemporary collection features Satin White glass shades of various shapes and sizes mounted on metal frames finished in a dramatic two-tone Gold with Black accents. Available as pendants, sconces, and portable lamp configurations

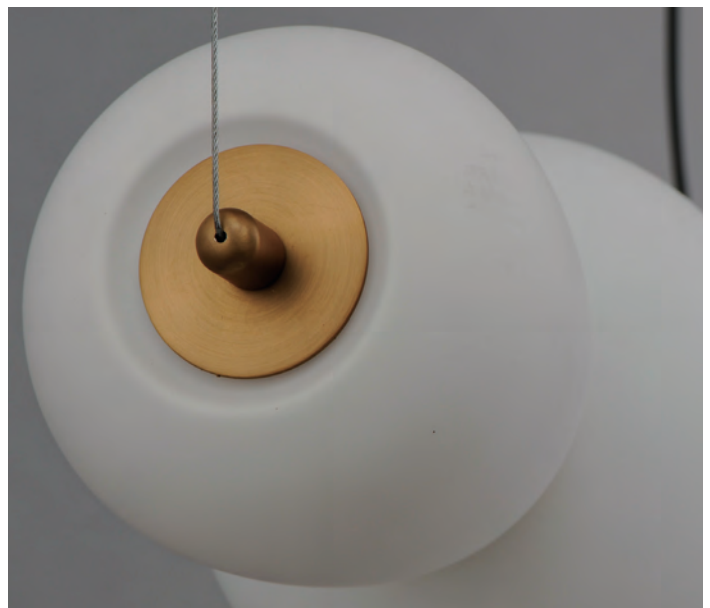
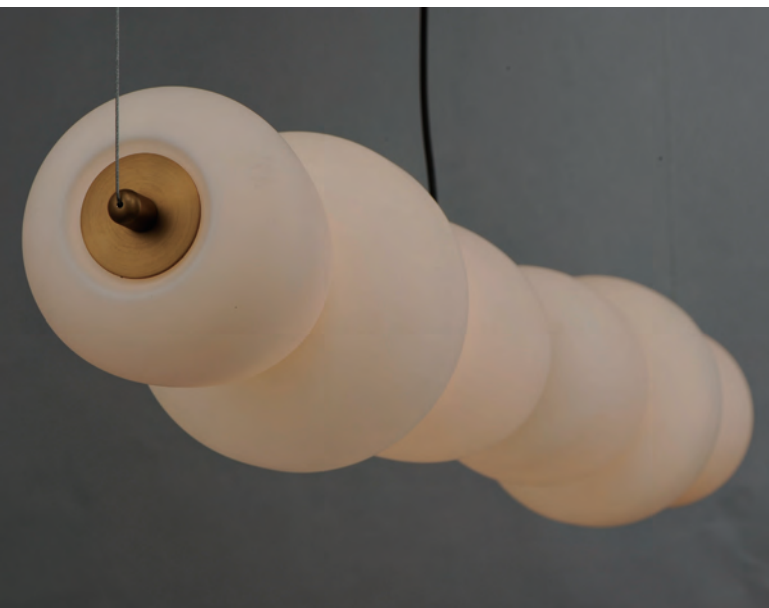

- LED Integrated, 3000K Color Temperature
- 120-277V Range Voltage Input
- 3-in-1 universal dimming: Triac/ELV at 120V or 0-10V dimming

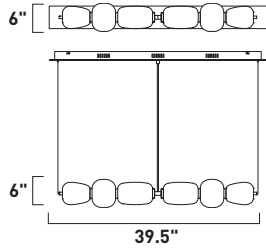
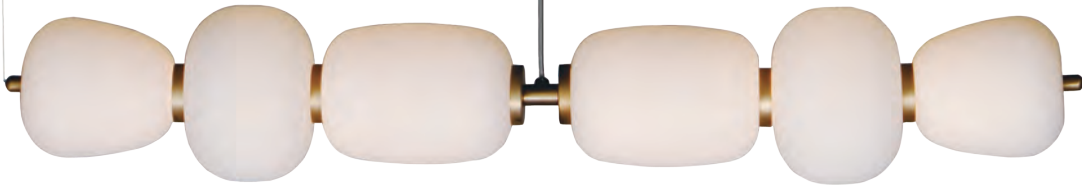

**E25068-92BKGLD**  
Pendant

**A**

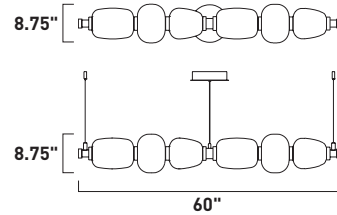
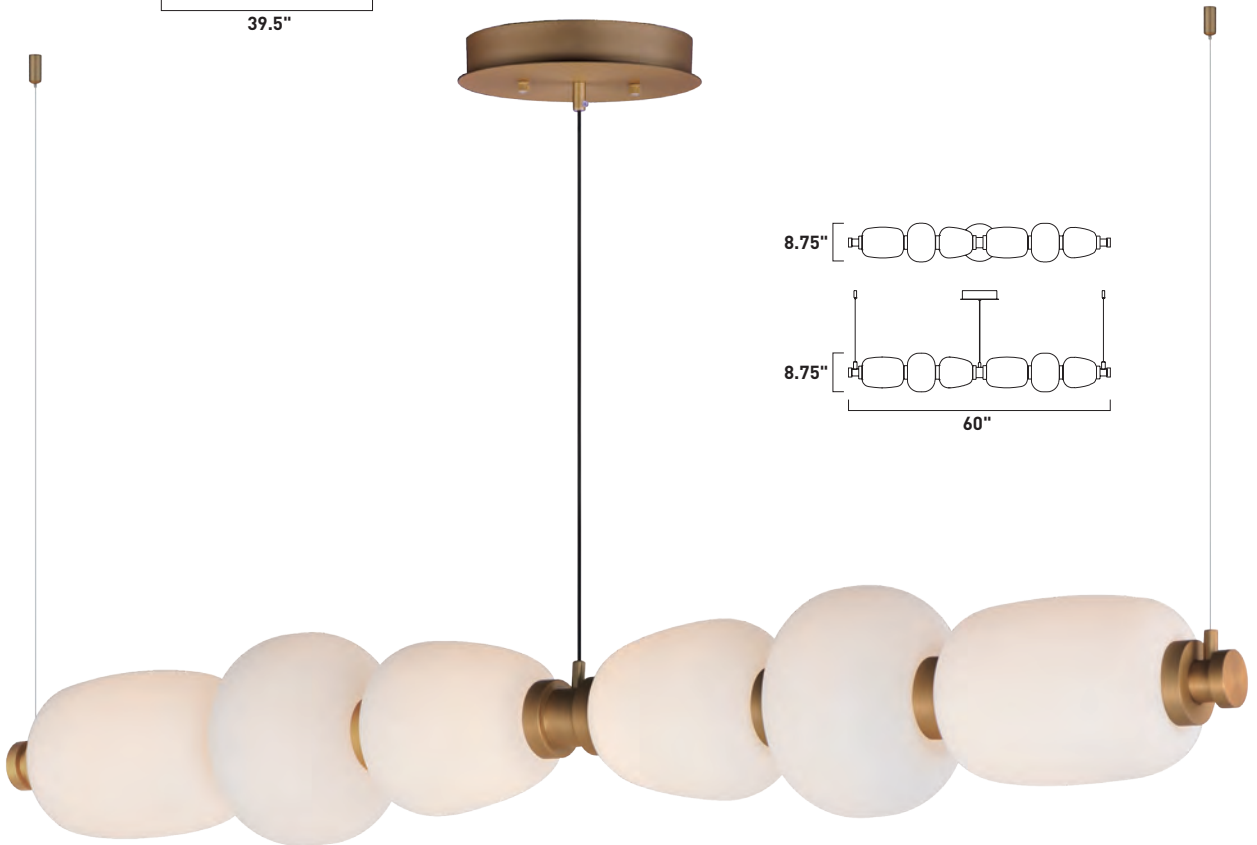

**E25168-92BKGLD**  
Pendant

**B**

ITEM #	FINISH	LAMPING	DIMENSION	LUMENS		Additional Information
				CRI	INIT. DEL.	
A	E25068 92BKGLD	34W PCB LED 3000K (Integrated)	39.5" L x 6" W x 6" H, 125" OAH	90+	1890 1570	LED DIM ⓘ
B	E25168 92BKGLD	60W PCB LED 3000K (Integrated)	60" L x 8.75" W x 8.75" H, 128.75" OAH	90+	4200 3000	LED DIM ⓘ

Finish: Satin White glass (92) Black/Gold (BKGLD)



# SOJI

- LED Integrated, 3000K Color Temperature
- 120-277V Range Voltage Input
- 3-in-1 universal dimming: Triac/ELV at 120V or 0-10V dimming



**E25069-92BKGLD**

Pendant

**A**

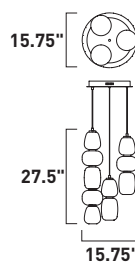

ITEM #	FINISH	LAMPING	DIMENSION	LUMENS			Additional Information
				CRI	INIT.	DEL.	
A E25069	92BKGLD	55W PCB LED 3000K (Integrated)	15.75"L x 15.75"W x 27.5"H, 150" OAH	90+	3200	2230	  

Finish: Satin White glass (92) Black/Gold (BKGLD)





**E25066-92BKGLD**  
Pendant

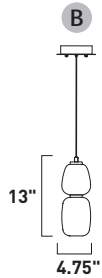

**E25067-92BKGLD**  
Pendant

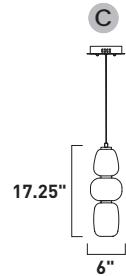

**E25166-92BKGLD**  
Table lamp

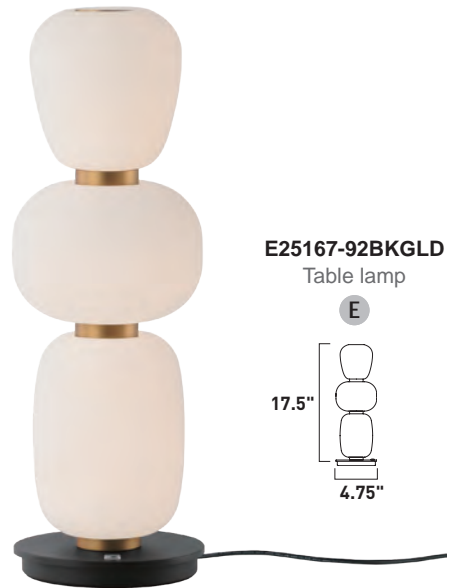
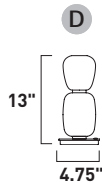

**E25167-92BKGLD**  
Table lamp

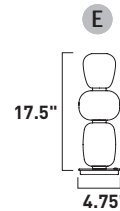

ITEM #	FINISH	LAMPING	DIMENSION	LUMENS CRI INIT. DEL.	Additional Information	
B	E25066	92BKGLD	10W PCB LED 3000K (Inte.)	4.75"L x 4.75"W x 13"H, 135" OAH	90+ 960 760	LED DIM UP
C	E25067	92BKGLD	13W PCB LED 3000K (Inte.)	6"L x 6"W x 17.25"H, 140" OAH	90+ 1040 930	LED DIM UP
D	E25166	92BKGLD	15W PCB LED 3000K (Inte.)	4.75"L x 4.75"W x 13"H	90+ 1050 690	LED DIM
E	E25167	92BKGLD	18.5W PCB LED 3000K (Inte.)	4.75"L x 4.75"W x 17.5"H	90+ 1300 910	LED DIM

Finish: Satin White glass (92) Black/Gold (BKGLD)



# SOJI

- LED Integrated, 3000K Color Temperature
- 120-277V Range Voltage Input
- 3-in-1 universal dimming: Triac/ELV at 120V or 0-10V dimming

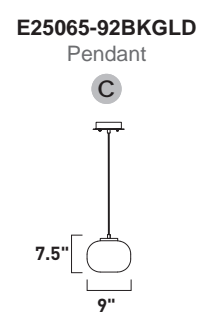
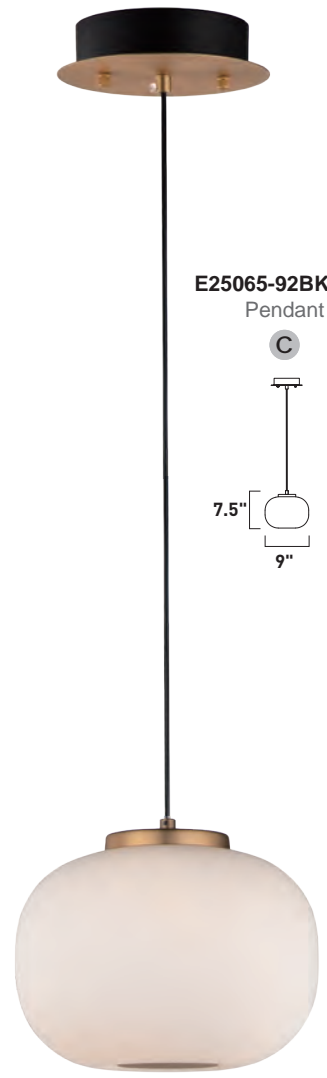
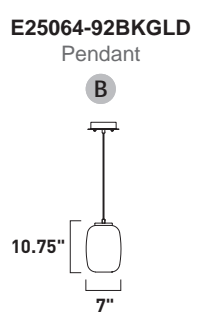
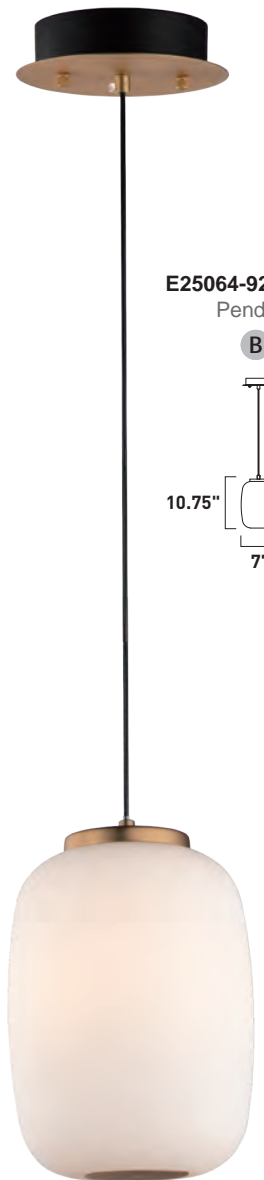
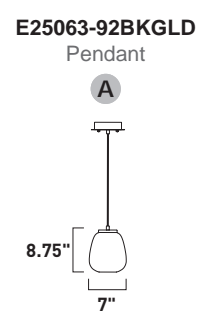
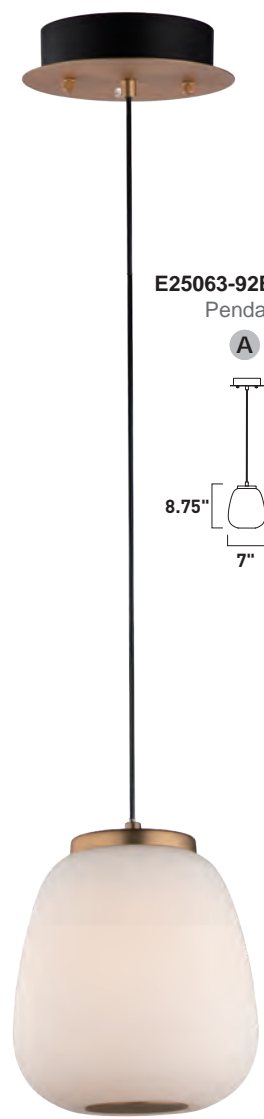

ITEM #	FINISH	LAMPING	DIMENSION	LUMENS			Additional Information	
				CRI	INIT.	DEL.		
A	E25063	92BKGLD	2 x 4W G9 LED 3000K (Incl.)	7"L x 7"W x 8.75"H, 131"OAH	90+	960	760	
B	E25064	92BKGLD	2 x 4W G9 LED 3000K (Incl.)	7"L x 7"W x 10.75"H, 133"OAH	90+	960	760	
C	E25065	92BKGLD	2 x 4W G9 LED 3000K (Incl.)	9"L x 9"W x 7.5"H, 131"OAH	90+	960	760	

Finish: Satin White glass (92) Black/Gold (BKGLD)





**E25061-92BKGLD**

Wall Mount

**D**

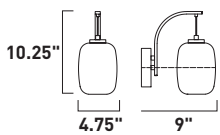

**E25062-92BKGLD**

Wall Mount

**E**

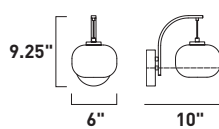

**E25060-92BKGLD**

Wall Mount

**F**

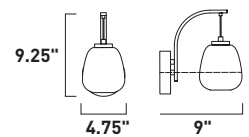

	ITEM #	FINISH	LAMPING	DIMENSION	HCO	LUMENS		Additional Information	
						INIT.	DEL.		
D	E25061	92BKGLD	1 x 4W G9 LED 3000K (Incl.)	4.75"W x 10.25"H x 9"Ext.	4.5"	90+	480	380	
E	E25062	92BKGLD	1 x 4W G9 LED 3000K (Incl.)	6"W x 9.25"H x 10"Ext.	5"	90+	480	380	
F	E25060	92BKGLD	1 x 4W G9 LED 3000K (Incl.)	4.75"W x 9.25"H x 9"Ext.	4.5"	90+	480	380	

Finish: Satin White glass (92) Black/Gold (BKGLD)

# SONATA

Composed of gently curving aluminum channels in Matte Black that supports a patterned translucent acrylic arranged in groups of vertical stripes, this series of pendants and coordinating ADA sconce expresses a musical quality in brilliant LED light. The wall sconce visibly suggests the shape of a piano, while the pendants return inward where they bend at the ends in an instrumental, elegant shape. A story told in simple forms, the collection is illuminated by dedicated LED light sources concealed within the frames enhancing the translucent undulating slabs of patterned acrylic. Their sculptural form is sure to add wonder to both classical and modern settings.

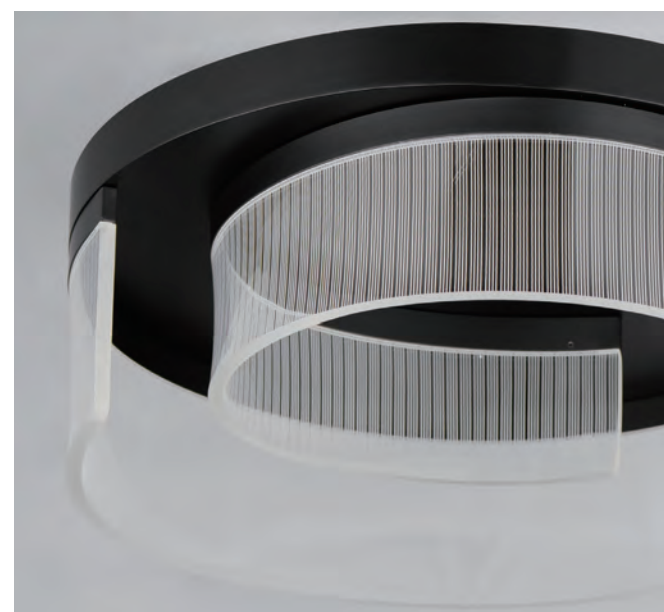



# SONATA

- Vertically striped translucent acrylic panes are bent by hand
- Stark contrasting Matte Black aluminum frame
- Integrated LED in a Neutral White 3000K color temperature
- ADA compliant wall sconce
- 120-270V Range Voltage Input
- 3-in-1 universal dimming: Triac/ELV at 120V or 0-10V dimming
- Configurations include Pendants, Wall Sconce, and Flush Mounts



**E24776-133BK**

Pendant

**A**

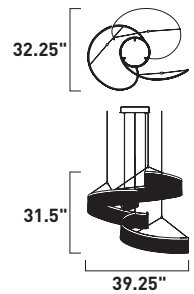

	ITEM #	FINISH	LAMPING	DIMENSION	LUMENS			Additional Information
					CRI	INIT.	DEL.	
<b>A</b>	E24776	133BK	86W PCB LED 3000K (Inte.)	39.25"L x 32.25"W x 31.5"H, 120"OAH	90+	6880	2900	LED 3000K 1

Finish: Patterned Acrylic (133) Black (BK)

# SONATA

- Vertically striped translucent acrylic panes are bent by hand
- Stark contrasting Matte Black aluminum frame
- Integrated LED in a Neutral White 3000K color temperature
- ADA compliant wall sconce
- 120-270V Range Voltage Input
- 3-in-1 universal dimming: Triac/ELV at 120V or 0-10V dimming
- Configurations include Pendants, Wall Sconce, and Flush Mounts

STRIPED VERTICAL LINES



**E24774-133BK**  
Pendant  
**A**

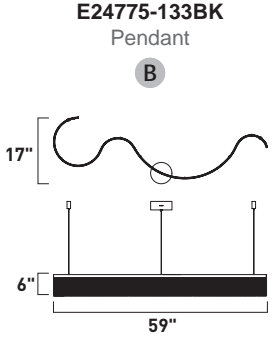
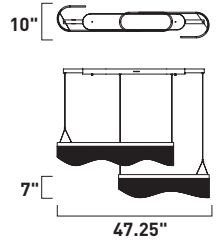

**E24775-133BK**  
Pendant  
**B**

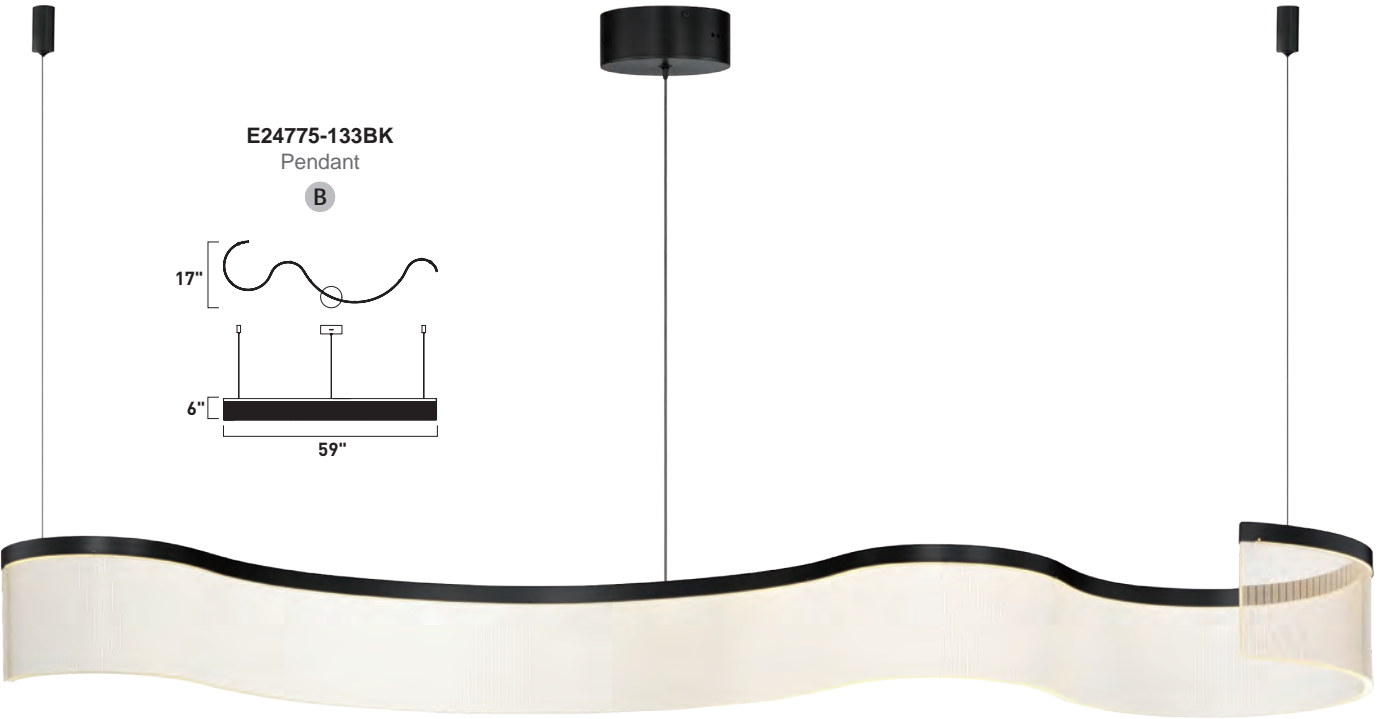

	ITEM #	FINISH	LAMPING	DIMENSION	LUMENS			Additional Information
					CRI	INIT.	DEL.	
<b>A</b>	E24774	133BK	54W PCB LED 3000K (Inte.)	47.25"L x 10"W x 7"H, 128.5" OAH	90+	2700	1250	LED DIM ⓘ
<b>B</b>	E24775	133BK	42W PCB LED 3000K (Inte.)	59"L x 17"W x 6"H, 126" OAH	90+	2940	1420	LED DIM ⓘ

Finish: Patterned Acrylic (133) Black (BK)



**E24779-133BK**  
Flush Mount

C

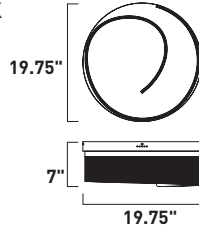

**E24778-133BK**  
Flush Mount

D

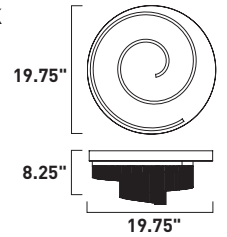

**E24771-133BK**  
Pendant

E

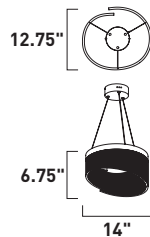

**E24772-133BK**  
Pendant

F

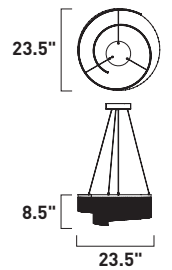

ITEM #	FINISH	LAMPING	DIMENSION	LUMENS			Additional Information	
				CRI	INIT.	DEL.		
C	E24779	133BK	35W PCB LED 3000K (Inte.)	19.75"L x 19.75"W x 7"H	90+	2450	1320	LED, DALI, UL60900
D	E24778	133BK	34W PCB LED 3000K (Inte.)	19.75"L x 19.75"W x 8.25"H	90+	3200	1140	LED, DALI, UL60900
E	E24771	133BK	24W PCB LED 3000K (Inte.)	14"L x 12.75"W x 6.75"H, 128.5" OAH	90+	1200	760	LED, DALI, UL60900, I
F	E24772	133BK	38W PCB LED 3000K (Inte.)	23.5"L x 23.5"W x 8.5"H, 130" OAH	90+	3200	2000	LED, DALI, UL60900, I

Finish: Patterned Acrylic (133) Black (BK)

# CHIMES 5CCT

Wide bands of Matte Black metal supports an evenly spaced row of thin tubing finished in your choice of Satin Brass, Satin Nickel or a combination of the two. The stylish design is CCT Selectable enabling you to toggle between warm 2700K to neutral 3000 or 3500K or even go brighter with 4000 and 5000K color temperatures. Marvel at the ring's soft indirect lighting dispersion cast light both up and down and shine along the tubes aglow. High style and function, this fixture's subtle features can transform not only the fixture's appearance but also the space where it is installed.





# CHIMES 5CCT

- Black band supports numerous tubes in your choice of: Satin Brass, Satin Nickel, or combined Satin Nickel/Satin Brass
- Adjustable Color Temperature Selectable Switch
- Toggle between 2700-3000-3500-4000-5000K Color Temperatures



**E34251-BKSBR, -BKSN**  
EWS34251-BK (Without tubes)  
Wall Mount

A

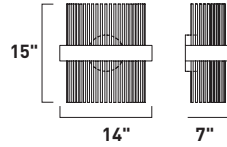

**E34257-BKSBR, -BKSN**  
EHP34257-BK (Without tubes)  
Pendant

C

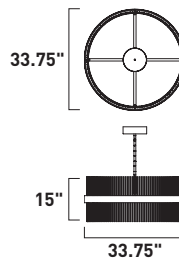

**E34255-BKSBR, -BKSN**  
EHP34255-BK (Without tubes)  
Pendant

B

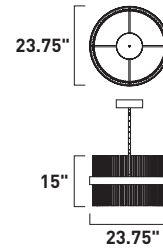

ITEM #	FINISH	LAMPING	DIMENSION	LUMENS		Additional Information			
				HCO	DEL.				
A	E34251	BKSBR, BKSN	17W LED 2700-3000-3500-4000-5000K (Inte.)	14" W x 15" H x 7" Ext.	7.5"	90+	1190	500	LED, 3000K, 4000K, 5000K, CCT
A	EWS34251	BK	17W LED 2700-3000-3500-4000-5000K (Inte.)	14" W x 5.5" H x 7" Ext.	2.5"	90+	1190	500	LED, 3000K, 4000K, 5000K, CCT
B	E34255	BKSBR, BKSN	53W LED 2700-3000-3500-4000-5000K (Inte.)	23.75" L x 23.75" W x 15" H, 56" OAH		90+	3710	1600	LED, 3000K, 4000K, 5000K, 90°, CCT
B	EHP34255	BK	53W LED 2700-3000-3500-4000-5000K (Inte.)	23.75" L x 23.75" W x 9" H, 50" OAH		90+	3710	1600	LED, 3000K, 4000K, 5000K, 90°, CCT
C	E34257	BKSBR, BKSN	73W LED 2700-3000-3500-4000-5000K (Inte.)	33.75" L x 33.75" W x 15" H, 56" OAH		90+	5110	2500	LED, 3000K, 4000K, 5000K, 90°, CCT
C	EHP34257	BK	73W LED 2700-3000-3500-4000-5000K (Inte.)	33.75" L x 33.75" W x 9" H, 50" OAH		90+	5110	2500	LED, 3000K, 4000K, 5000K, 90°, CCT

Finish Options: Black (BK) Black/Satin Nickel (BKSN) Black/Satin Brass (BKSBR)



# MANTA

An undulating shape softly curls along its center to create an organic form constructed of a single panel of transparent acrylic. Further enhancing the form is the captivating effect of the frosted band around the borders and the patterned etching on the acrylic that captures the light. A coordinating wall sconce that features the same curled acrylic material and extends only 4 inches from the wall for ADA compliant applications.

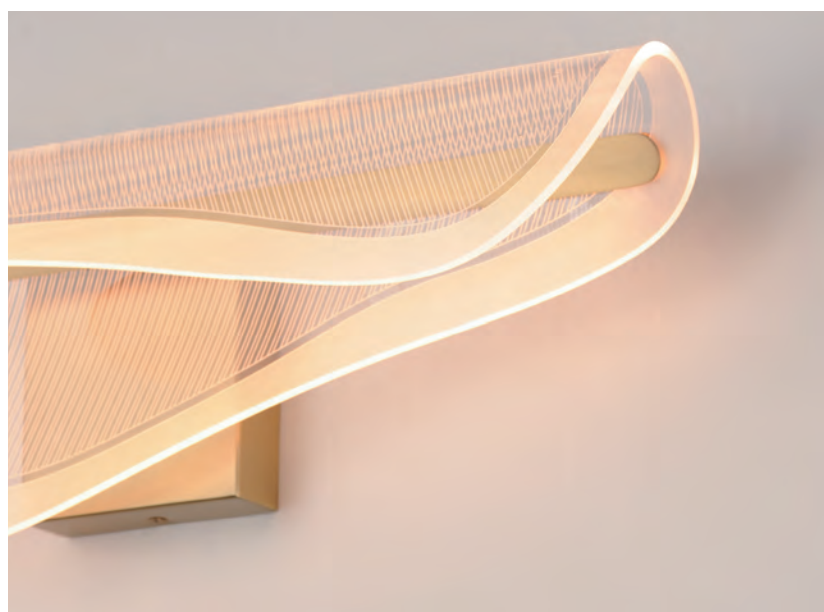
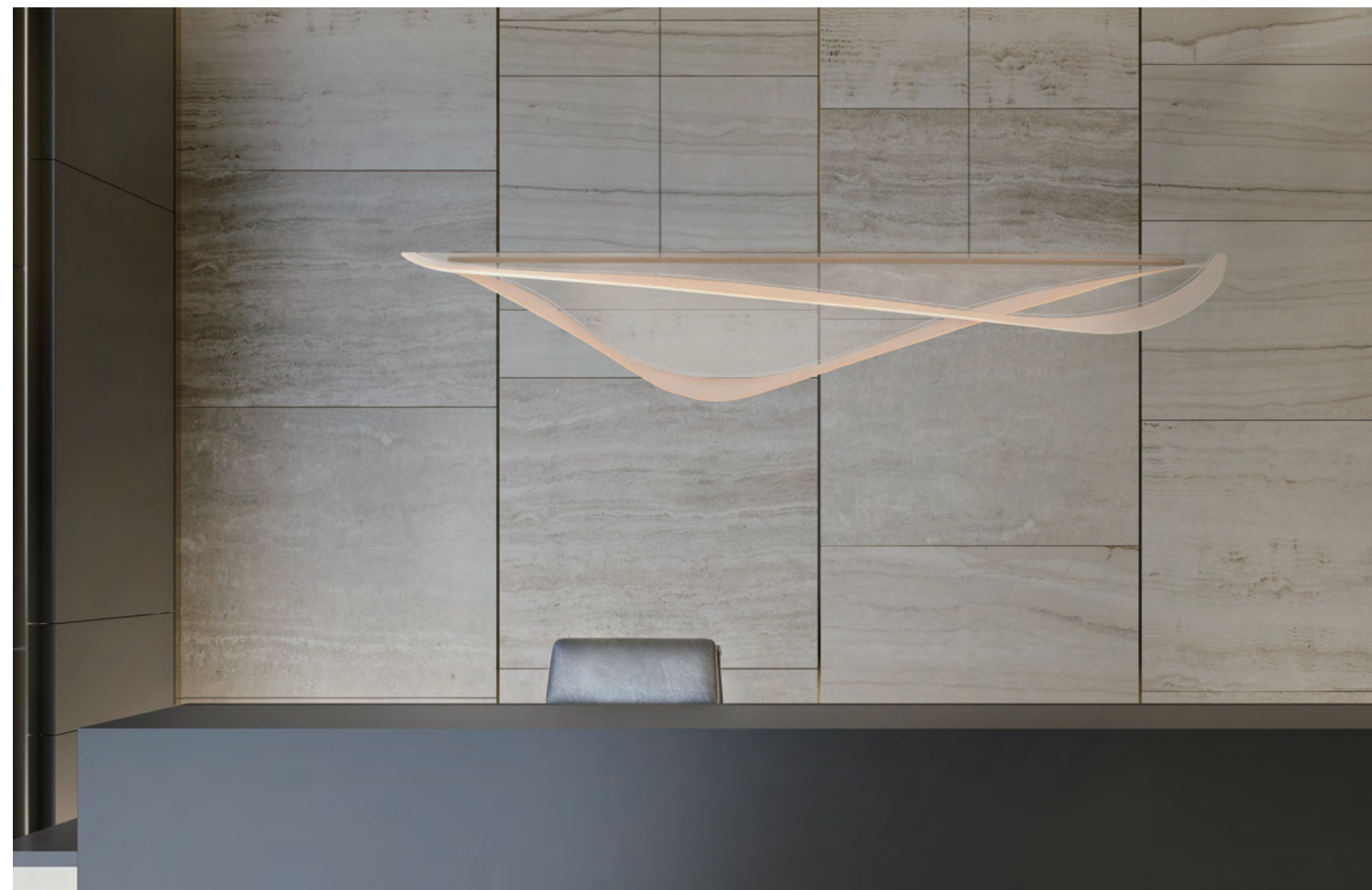

# MANTA

- Hand formed transparent acrylic with unique pattern
- Available in plated Gold or Matte Black
- LED Integrated, 3000K Color Temperature
- 120-277V Range Voltage Input
- 3-in-1 universal dimming: Triac/ELV at 120V or 0-10V dimming



**E24718-144BK, -144GLD, -144PC**  
Pendant

**A**

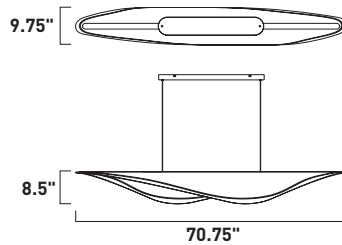

ITEM #	FINISH	LAMPING	DIMENSION	LUMENS			Additional Information
				CRI	INIT.	DEL.	
A E24718	144BK, 144GLD, 144PC	65W PCB LED 3000K (Inte.)	70.75"L x 9.75"W x 8.5"H, 128"OAH	90+	5200	3040	

Finish Options: Clear Ribbed glass (144) Black (BK) Gold (GLD) Polished Chrome (PC)

# MANTA

- Hand formed transparent acrylic with unique pattern
- Available in plated Gold or Matte Black
- LED Integrated, 3000K Color Temperature
- 120-277V Range Voltage Input
- 3-in-1 universal dimming: Triac/ELV at 120V or 0-10V dimming



**E24714-144BK, -144GLD, -144PC**  
Pendant

**A**

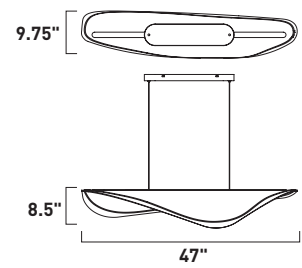

**E24716-144BK, -144GLD, -144PC**  
Pendant

**B**

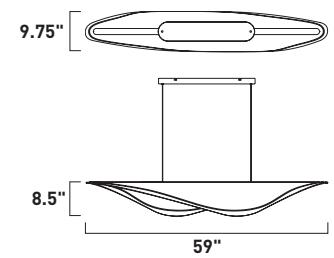

	ITEM #	FINISH	LAMPING	DIMENSION	LUMENS			Additional Information
					CRI	INIT.	DEL.	
A	E24714	144BK, 144GLD, 144PC	44W PCB LED 3000K (Inte.)	47" L x 9.75" W x 8.5" H, 128" OAH	90+	3080	2300	LED DIM ↑
B	E24716	144BK, 144GLD, 144PC	56W PCB LED 3000K (Inte.)	59" L x 9.75" W x 8.5" H, 128" OAH	90+	4480	2770	LED DIM ↑

Finish Options: Clear Ribbed glass (144) Black (BK) Gold (GLD) Polished Chrome (PC)



**E24711-144BK, -144GLD, -144PC**  
Wall Mount

**C**

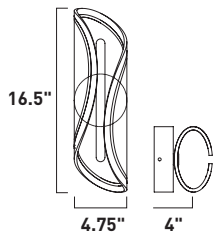

**E24712-144BK, -144GLD, -144PC**  
Bath Vanity

**D**

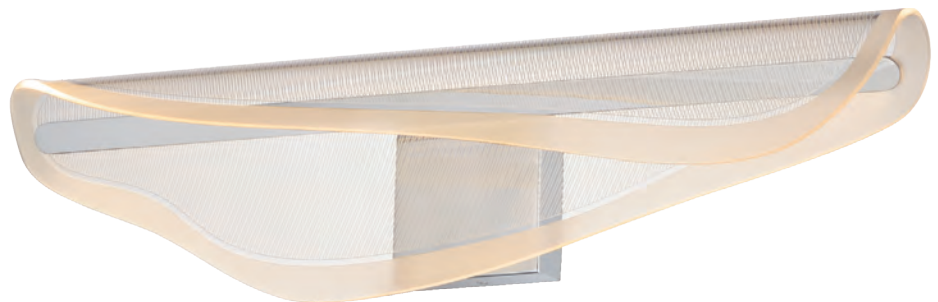
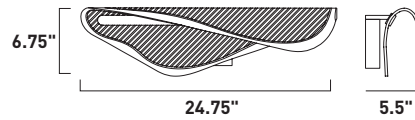

**E24713-144BK, -144GLD, -144PC**  
Bath Vanity

**E**

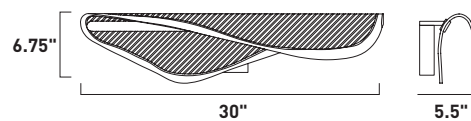

ITEM #	FINISH	LAMPING	DIMENSION	HCO	CRI	LUMENS		Additional Information
						INIT.	DEL.	
C	E24711 : 144BK, 144GLD, 144PC	12W PCB LED 3000K (Inte.)	4.75" W x 16.5" H x 4" Ext.	8.25"	90+	960	750	
D	E24712 : 144BK, 144GLD, 144PC	20W PCB LED 3000K (Inte.)	24.75" W x 6.75" H x 5.5" Ext.	3.5"	90+	1440	900	
E	E24713 : 144BK, 144GLD, 144PC	20W PCB LED 3000K (Inte.)	30" W x 6.75" H x 5.5" Ext.	3.5"	90+	1440	900	

Finish Options: Clear Ribbed glass (144) Black (BK) Gold (GLD) Polished Chrome (PC)



# VOTO

Shallow glass domes encase edge-lit LED panels, creating a captivating play of light that highlights the void within each fixture while delivering evenly distributed illumination both upwards and downwards where applicable. A meticulously crafted frame conceals the hardware, resulting in a sleek, modern LED composition. The collection is available in two sophisticated finishes—Clear Glass with a Gold-plated frame and Mirror Smoked Glass with a Gunmetal frame—and includes a 2-light LED pendant, a versatile flush mount that doubles as a wall-mountable fixture, and a portable lamp option.

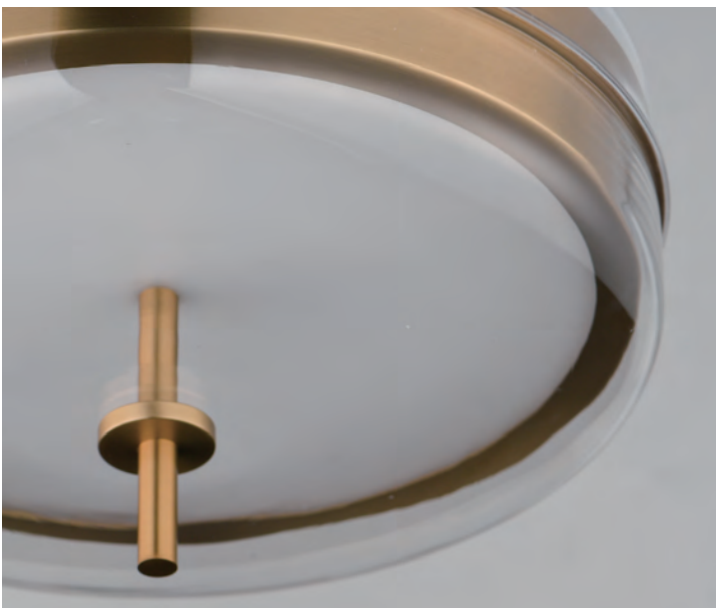



- Clear or Smoked Glass Options
- Edge-lit LED panel encased within glass
- Available in plated Gold or Gunmetal



**E24660-138GM, -18NAB**  
Flush Mount

**A**

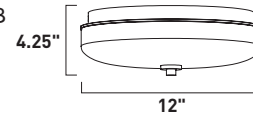

**E24662-138GM, -18NAB**  
Pendant

**B**

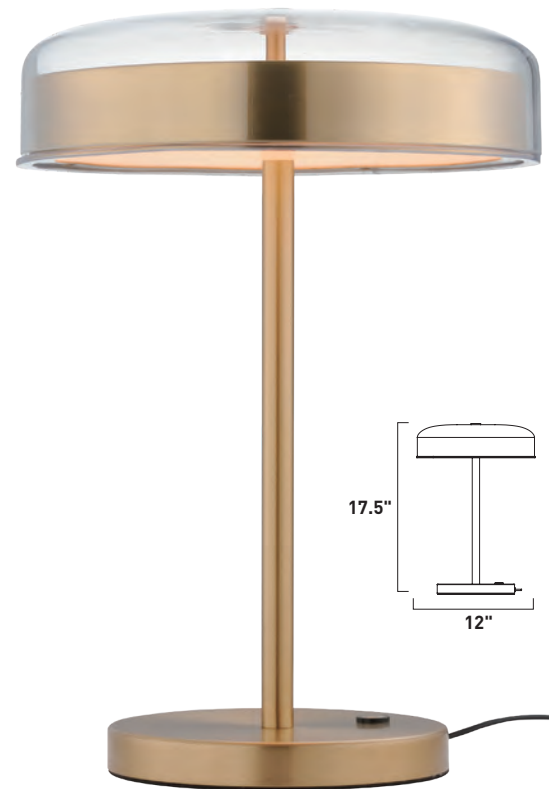
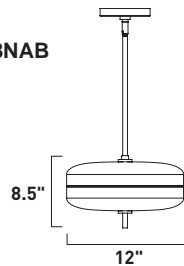

**E24669-138GM, -18NAB**  
Table Lamp

**C**

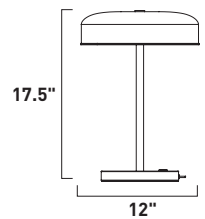

ITEM #	FINISH	LAMPING	DIMENSION	LUMENS			Additional Information
				CRI	INIT.	DEL.	
A	E24660 : 138GM, 18NAB	1 x 16W PCB LED 3000K (Inte.)	12"L x 12"W x 4.25"H	90+	1640	1050	LED, DIM
B	E24662 : 138GM, 18NAB	2 x 12W PCB LED 3000K (Inte.)	12"L x 12"W x 8.5"H, 53" OAH	90+	1680	900	LED, DIM, I
C	E24669 : 138GM, 18NAB	2 x 8W PCB LED 3000K (Inte.)	12"L x 12"W x 17.5"H	90+	1000	750	LED, DIM

Finish Options: Graduating Smoke glass (138) Clear glass (18) Gunmetal (GM) Natural Aged Brass (NAB)

# GROOVE 5CCT

Our best-selling simple LED integrated rings formed out of aluminum channel. Available in your choice of Matte Black or Brushed Gold, these modern staples of lighting design are enhanced by a recessed LED downlight that is enabled with CCT Selectable features. Select from 5 color temperature settings from warm 2700K to a bright 5000K. Enable smart features when choosing the Connected by WiZ options. Users can tune the color temperature, set lighting schedules and routines, and freely adjust the temperature of the lighting to match their interiors or set a mood.

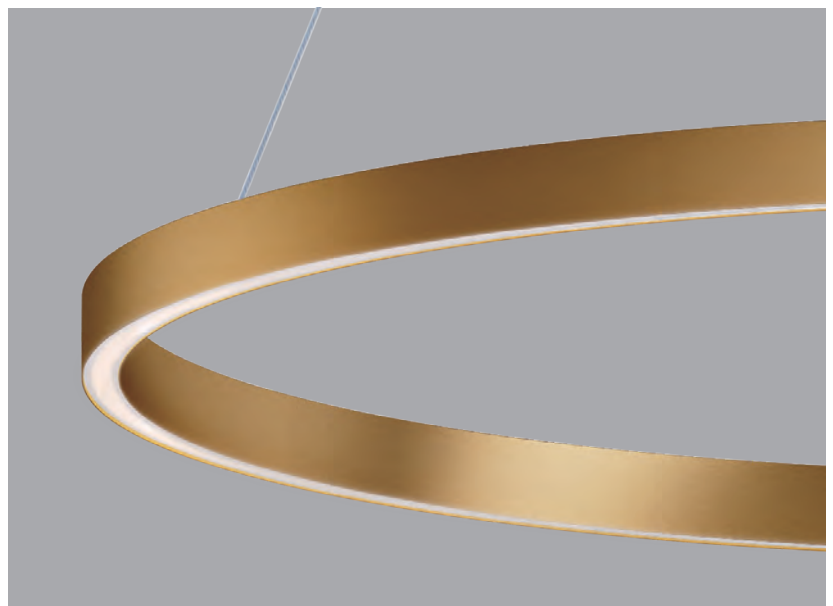
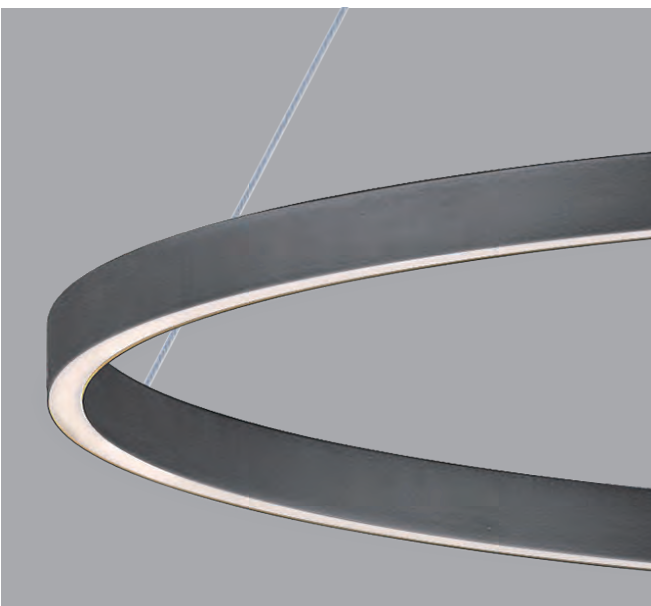

# GROOVE 5CCT

- Diameters up to 40"
- Smart Life app recommended
- Adjustable Color Temperature Selectable Switch
- Toggle between 2700-3000-3500-4000-5000K Color Temperatures



**E52720-AL, -BK, -GLD**  
Flush Mount

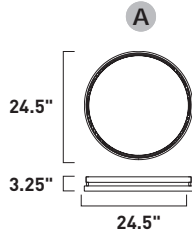

**E52729-AL, -BK, -GLD**  
Pendant

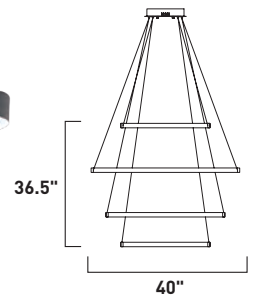

	ITEM #	FINISH	LAMPING	DIMENSION	LUMENS			Additional Information
					CRI	INIT.	DEL.	
A	E52720	AL, BK, GLD	27W PCB LED 2700-3000-3500-4000-5000K (Inte.)	24.5"L x 24.5"W x 3.25"H	90+	1890	1100	
B	E52729	AL, BK, GLD	160W PCB LED 2700-3000-3500-4000-5000K (Inte.)	40"L x 40"W x 36.5"H, 123.5" OAH	90+	11,200	7000	

Finish Options: Aluminum (AL) Black (BK) Gold (GLD)

# GROOVE 5CCT

- Diameters up to 40"
- Smart Life app recommended
- Adjustable Color Temperature Selectable Switch
- Toggle between 2700-3000-3500-4000-5000K Color Temperatures



**E52726-AL, -BK, -GLD**  
Pendant  
**B**

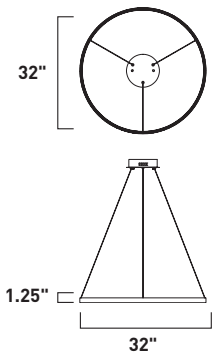

**E52724-AL, -BK, -GLD**  
Pendant  
**A**

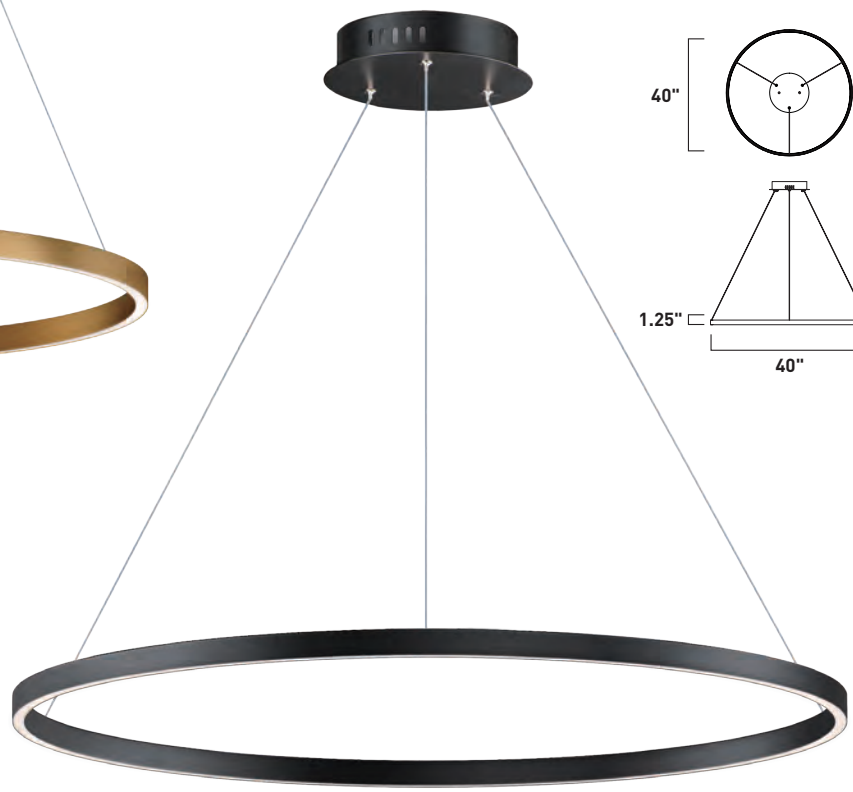
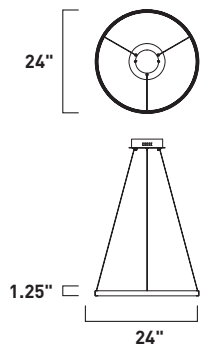

**E52728-AL, -BK, -GLD**  
Pendant  
**C**

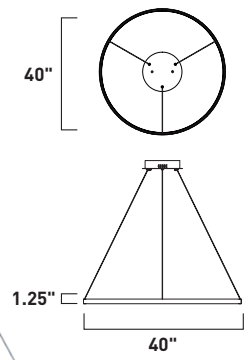

ITEM #	FINISH	LAMPING	DIMENSION	LUMENS	Additional Information
				CRI INIT. DEL.	
A	E52724 AL, BK, GLD	27W PCB LED 2700-3000-3500-4000-5000K (Inte.)	24"L x 24"W x 1.25"H, 123.5" OAH	90+ 1890 1100	
B	E52726 AL, BK, GLD	35W PCB LED 2700-3000-3500-4000-5000K (Inte.)	32"L x 32"W x 1.25"H, 123.5" OAH	90+ 2450 1400	
C	E52728 AL, BK, GLD	42W PCB LED 2700-3000-3500-4000-5000K (Inte.)	40"L x 40"W x 1.25"H, 123.5" OAH	90+ 2940 1600	

Finish Options: Aluminum (AL) Black (BK) Gold (GLD)







# HOOPLA

Rings of various sizes finished in Black are supported from a column of soft Gold. This European classic is a soft contemporary design which works in today's home decor.



# HOOPLA

- Black or White with Gold finish
- 3000K Color Temperature, CRI 90+
- 120-270V Range Voltage Input
- 3-in-1 universal dimming: Triac/ELV at 120V or 0-10V dimming
- ADA Wall Sconce



**E24325-BKGLD, -WTGLD**

Pendant

**A**

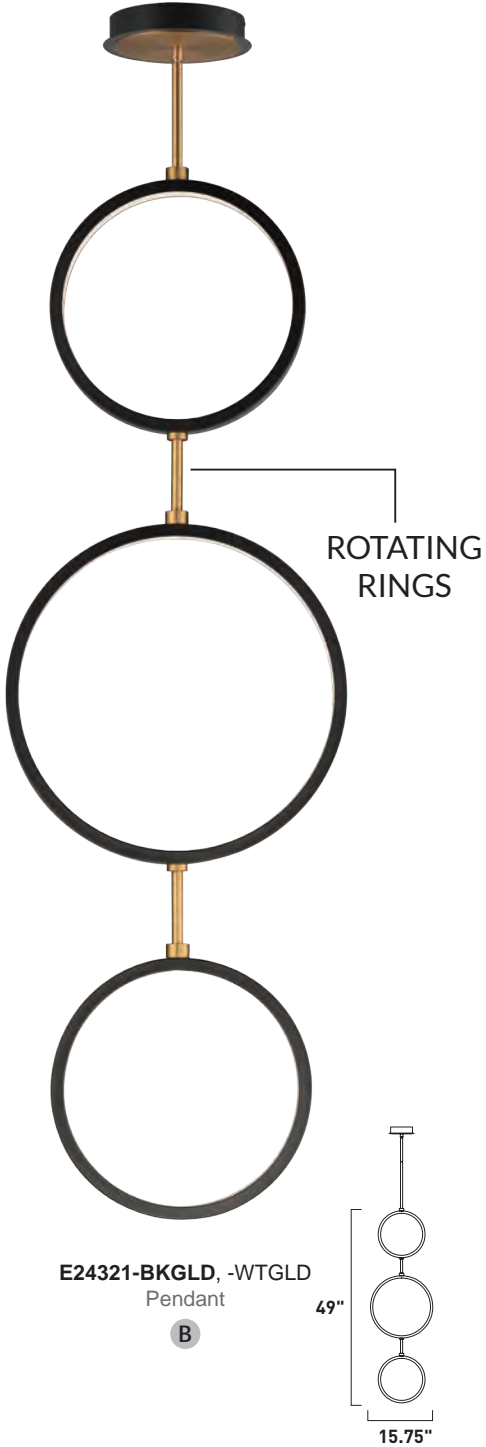
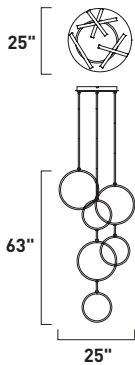

ROTATING RINGS

**E24321-BKGLD, -WTGLD**

Pendant

**B**

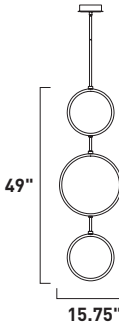

ITEM #	FINISH	LAMPING	DIMENSION	LUMENS			Additional Information
				CRI	INIT.	DEL.	
A	E24325 BKGLD, WTGLD	6 x 15W PCB LED 3000K (Inte.)	25" L x 25" W x 63" H, 93" OAH	90+	9000	2500	LED 3000K ⓘ
B	E24321 BKGLD, WTGLD	3 x 14W PCB LED 3000K (Inte.)	15.75" L x 15.75" W x 49" H, 93" OAH	90+	3500	1500	LED 3000K ⓘ

Finish Options: Black/Gold (BKGLD) White/Gold (WTGLD)

# HOOPLA

- Black or White with Gold finish
- 3000K Color Temperature, CRI 90+
- 120-270V Range Voltage Input
- 3-in-1 universal dimming: Triac/ELV at 120V or 0-10V dimming
- ADA Wall Sconce

• Rotated Rings

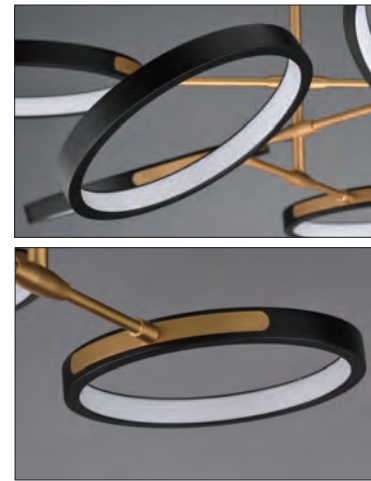

**E24322-BKGLD, -WTGLD**  
Pendant

**A**

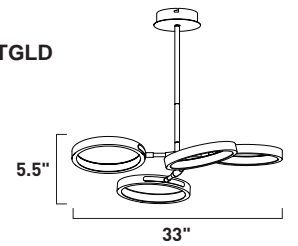

**E24328-BKGLD, -WTGLD**  
Pendant

**B**

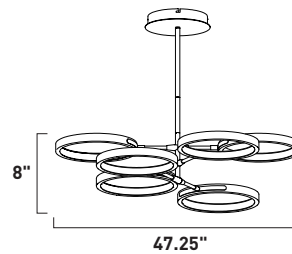

ITEM #	FINISH	LAMPING	DIMENSION	LUMENS		Additional Information
				CRI	INIT. DEL.	
A	E24322 BKGLD, WTGLD	4 x 12W PCB LED 3000K (Inte.)	33"L x 33"W x 5.5"H, 49.5" OAH	90+	4000 1700	LED DIM ↑
B	E24328 BKGLD, WTGLD	6 x 15W PCB LED 3000K (Inte.)	47.25"L x 47.25"W x 8"H, 52.25" OAH	90+	9000 3300	LED DIM ↑

Finish Options: Black/Gold (BKGLD) White/Gold (WTGLD)



**E24320-BKGLD, -WTGLD**  
Wall Mount

**C**

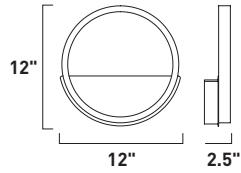

**E24326-BKGLD, -WTGLD**  
Pendant

**D**

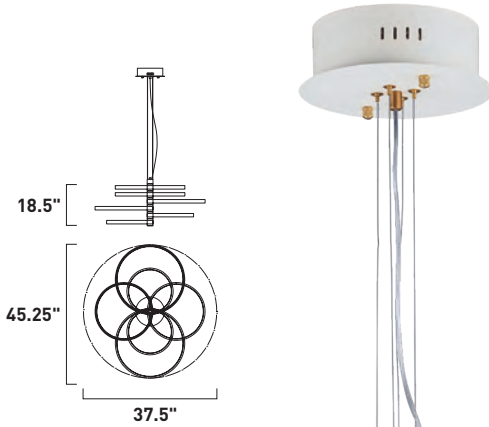
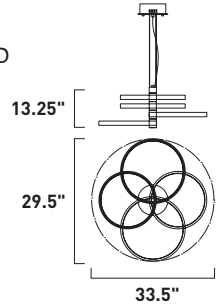

**E24327-BKGLD, -WTGLD**  
Pendant

**E**

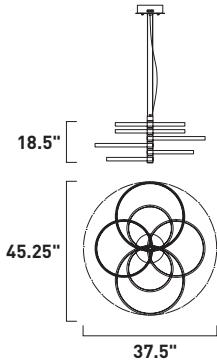

**E24323-BKGLD, -WTGLD**  
Semi-Flush Mount

**F**

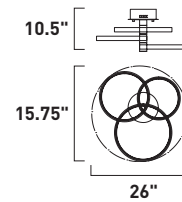

ITEM #	FINISH	LAMPING	DIMENSION	LUMENS			Additional Information
				HCO	CRI	INIT. DEL.	
C	E24320 BKGLD, WTGLD	12W PCB LED 3000K (Inte.)	12"W x 12"H x 2.5" Ext.	10"	90+	1000 600	LED, DALI, 0-10V, LRA
D	E24326 BKGLD, WTGLD	4 x 18.5W PCB LED 3000K (Inte.)	33.5"L x 29.5"W x 13.25"H, 134.25" OAH		90+	7000 2800	LED, DALI, 0-10V, LRA
E	E24327 BKGLD, WTGLD	6 x 22W PCB LED 3000K (Inte.)	45.25"L x 37.5"W x 18.5"H, 139" OAH		90+	11000 4500	LED, DALI, 0-10V, LRA
F	E24323 BKGLD, WTGLD	3 x 12W PCB LED 3000K (Inte.)	26"L x 15.75"W x 10.5"H		90+	4000 1800	LED, DALI, 0-10V, LRA

Finish Options: Black/Gold (BKGLD) White/Gold (WTGLD)



# PIROUETTE

Twisted Black forms are illuminated on the edge with integrated LED to emphasize a spiraling effect. Available in pendant configurations, the collection is complemented by bath vanities in the same style. The vanity lights feature CCT Selectable light sources that allow you to adjust the color temperature of the lighting that best suits your application.





# PIROUETTE

- Twisted Aluminum construction in matte Black finish
- 3200K Color Temperature
- CRI 90+
- Dimmable with Triac dimmers



**E24151-BK**  
Pendant

**A**

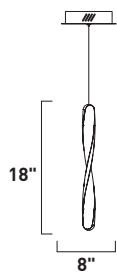

**E24154-BK**  
Pendant

**B**

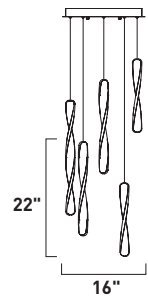

	ITEM #	FINISH	LAMPING	DIMENSION	LUMENS CRI INIT. DEL.	Additional Information
<b>A</b>	E24151	BK	16W PCB LED 3200K (Inte.)	8"L x 8"W x 18"H, 146"OAH	90+ 1120 1040	LED 3200K ↑
<b>B</b>	E24154	BK	66W PCB LED 3200K (Inte.)	16"L x 16"W x 22"H, 142.5"OAH	90+ 4620 3900	LED 3200K ↑

Finish: Black (BK)

# PIROUETTE

- Twisted Aluminum construction in matte Black finish
- 3200K Color Temperature
- CRI 90+
- Dimmable with Triac dimmers

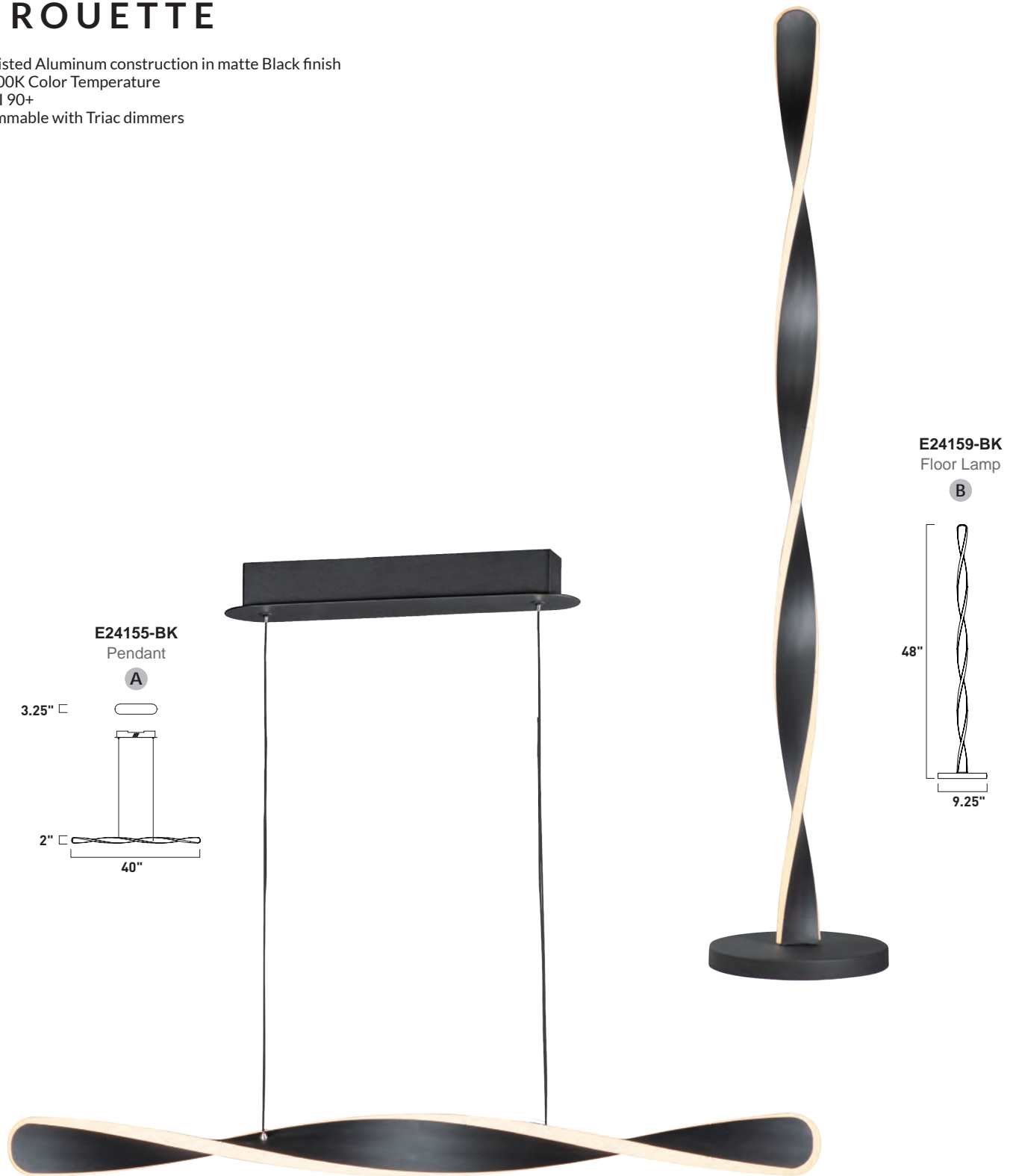

	ITEM #	FINISH	LAMPING	DIMENSION	LUMENS			Additional Information
					CRI	INIT.	DEL.	
A	E24155	BK	32W PCB LED 3200K (Inte.)	40"L x 3.25"W x 2"H, 132" OAH	90+	2240	2400	LED
B	E24159	BK	40W PCB LED 3200K (Inte.)	9.25"L x 9.25"W x 48"H	90+	2800	2800	LED

Finish: Black (BK)

CCT SELECTABLE



**E24152-BK**  
Bath Vanity

**C**

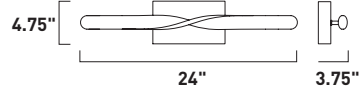

**E24153-BK**  
Bath Vanity

**D**

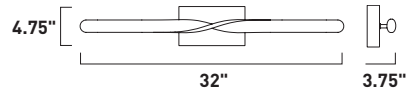

	ITEM #	FINISH	LAMPING	DIMENSION	LUMENS			Additional Information	
					HCO	CRI	INIT. DEL.		
C	E24152	BK	15W LED 2700-3000-3500-4000-5000K (Inte.)	24"W x 4.75"H x 3.75"Ext.	4"	90+	1350	900	
D	E24153	BK	25W LED 2700-3000-3500-4000-5000K (Inte.)	32"W x 4.75"H x 3.75"Ext.	4"	90+	2250	1500	

Finish: Black (BK)

# EMBRACE

A modern matte black frame crafted with rectilinear tubing supports circular LED light modules. Designed to appear as if they are facing each other in an embrace, the modules create a harmonious and dynamic aesthetic. The two modules, positioned at opposite ends, cast evenly distributed light and seamlessly rotate to direct illumination precisely where it's needed. Two versatile surface-mount fixtures are suitable for wall or ceiling installation, as well as two portable lamp options. The portable designs feature a tabletop lamp and a larger-profile floor lamp, both equipped with an integrated touch switch for easy operation and dimming control.

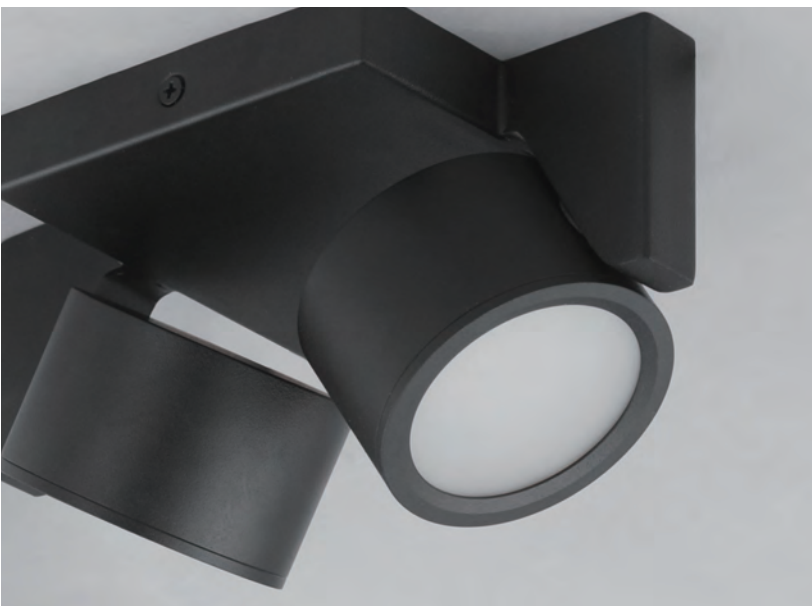

# EMBRACE

- Rotating light modules in round housings
- Matte Black rectilinear frame
- 3000K Color Temperature
- Sconce and Portable Lamp configurations

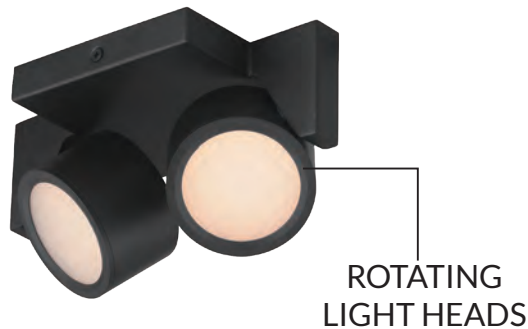
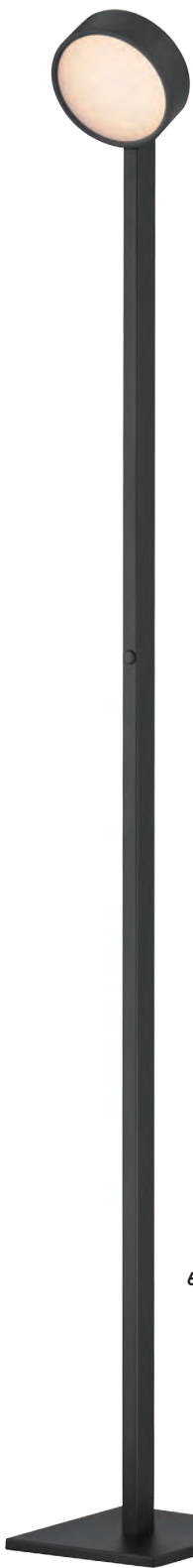

**E30520-BK**  
Flush Mount

A

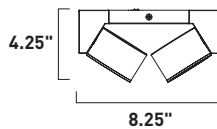

**E30521-BK**  
Wall Mount

B

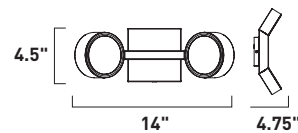

**E30529-BK**  
Floor Lamp

C

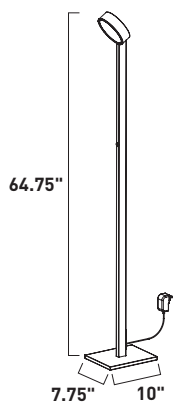

**E30523-BK**  
Table Lamp

D

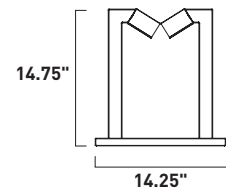

ITEM #	FINISH	LAMPING	DIMENSION	HCO	CRI	LUMENS INIT.	LUMENS DEL.	Additional Information
A	E30520 BK	2 x 5W PCB LED 3000K (Inte.)	8.25"L x 4.75"W x 4.25"H		90+	900	600	LED DIM
B	E30521 BK	2 x 5W PCB LED 3000K (Inte.)	14"W x 4.5"H x 4.75"Ext.	2.5"	90+	900	600	LED DIM TOUCH DIM
C	E30529 BK	1 x 10W PCB LED 3000K (Inte.)	10"L x 7.75"W x 64.75"H		90+	900	600	LED DIM
D	E30523 BK	2 x 5W PCB LED 3000K (Inte.)	14.25"L x 4.75"W x 14.75"H		90+	900	600	LED DIM

Finish: Black (BK)





# SIDELINE 5CCT VANITY

A straight line profile of aluminum casts lights along the length of the profile in both directions with adjustable color temperatures. Simply toggle between the 5 settings: 2700-3000-3500-4000-500K to suit the space where it is installed. Available in outdoor configurations in powder coat finishes including: Black and Architectural Bronze. A variation of the sconce is plated in Natural Aged Brass and Polished Chrome suitable for interior spaces such as above bath vanities.



# SIDELINE 5CCT

- Anti corrosive aluminum construction
- Varying lengths from 18" to 30"
- CCT Selectable: 2700-3000-3500-4000-5000K
- Dimmable via Triac or ELV
- Interior and Exterior configurations
- Outdoor rated powder coat options include: Black and Architectural Bronze
- Interior finish options include Natural Aged Brass and Polished Chrome
- ADA Compliant

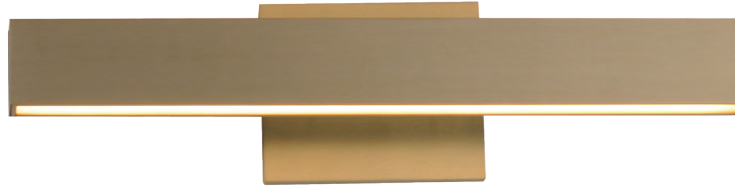

**E42661-NAB, -PC** 4.75" [ ]  
Bath Vanity  
**A**



CCT SWITCH —   
**E42662-NAB, -PC** 4.75" [ ]  
Bath Vanity  
**B**

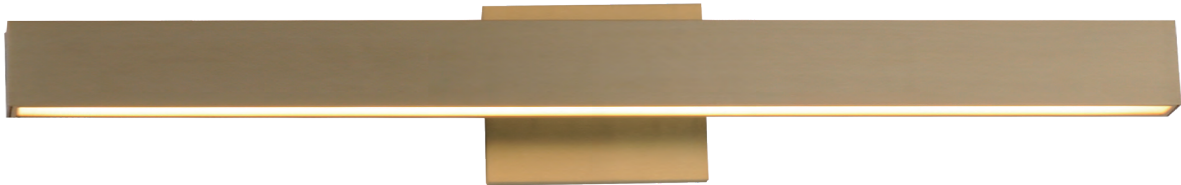

**E42663-NAB, -PC** 4.75" [ ]  
Bath Vanity  
**C**

ITEM #	FINISH	LAMPING	DIMENSION	HCO	CRI	LUMENS		Additional Information
						INIT.	DEL.	
A	E42661 NAB, PC	2 x 9W LED 2700-3000-3500-4000-5000K (Inte.)	18"W x 4.75"H x 3" Ext.	2.25"	90+	1260	820	
B	E42662 NAB, PC	2 x 12W LED 2700-3000-3500-4000-5000K (Inte.)	24"W x 4.75"H x 3" Ext.	2.25"	90+	1680	1220	
C	E42663 NAB, PC	2 x 15W LED 2700-3000-3500-4000-5000K (Inte.)	30"W x 4.75"H x 3" Ext.	2.25"	90+	2100	1550	

Finish Options: Natural Aged Brass (NAB) Polished Chrome (PC)

# FLOATING LED MIRRORS

LED mirrors are an excellent addition to any upscale home. These mirrors excel in top of the line quality, features, and appearance. Not only can you adjust the brightness but you also can change the color temperature to enhance the design of the room and other functional applications. Available in a variety of sizes and shapes you are sure to find a perfect match to your décor.





# FLOATING LED MIRRORS

- Touch Dimmable
- Plug in or direct wire
- CRI 90+
- Dimmable with Triac dimmers



**E42036-GLBK**  
Mirror

**A**

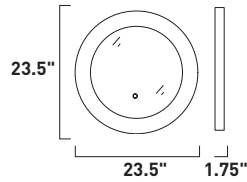

**E42040-GLBK**  
Mirror

**B**

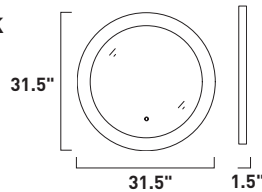

**E42046-GLBK**  
Free Standing or Wall Mirror

**C**

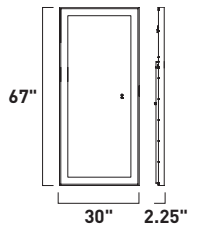

ITEM #	FINISH	LAMPING	DIMENSION	HCO	CRI	LUMENS INIT.	LUMENS DEL.	Additional Information	
A	E42036	GLBK	24W PCB LED 3000K (Inte.)	23.5"W x 23.5"H x 1.75"Ext.	11.75"	90+	1920	1795	
B	E42040	GLBK	28W PCB LED 3000K (Inte.)	31.5"W x 31.5"H x 1.5"Ext.	15.75"	90+	2240	2087	
C	E42046	GLBK	60W PCB LED 3000K (Inte.)	30"W x 67"H x 2.25"Ext.		90+	6000	1200	

Finish: Golden/Black (GLBK)



# BEVEL LED MIRRORS

White Acrylic diffusers are miter cut and beveled along the edge of these mirror frames allowing for wider, and brighter lighting. Robust in size, these mirrors are feature excellent construction and 5CCT light selection using a discreet touch switch on the frames edge. Hardwire the mirrors to a dimmer switch to control the brightness and the memory function on the LED will recall the chosen color temperature of the previous setting.



# BEVEL LED MIRRORS

- Miter cut beveled edge acrylic
- Available in Brushed Black or Satin Nickel
- Discreet touch dimmable switch on frame
- 2 CCT Select: 3000-4000K
- Plug-in or Direct Wire
- CRI 90+



**E42061-BBK, -SN**  
Mirror

**B**

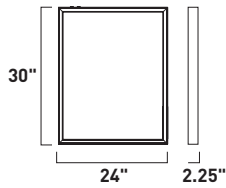

**E42062-BBK, -SN**  
Mirror

**C**

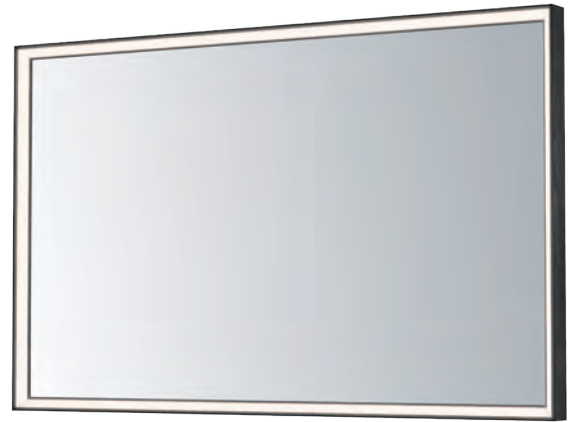
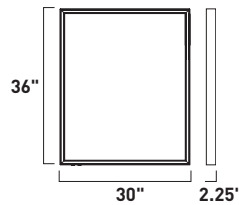

**E42063-BBK, -SN**  
Mirror

**D**

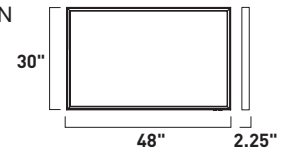

**E42064-BBK, -SN**  
Mirror

**E**

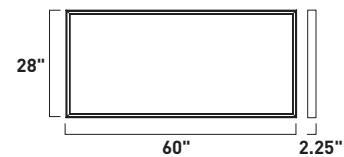

ITEM #	FINISH	LAMPING	DIMENSION	CRI	LUMENS INIT.	LUMENS DEL.	Additional Information	
A	E42065	BBK, SN	47W PCB LED 3000K (Inte.)	24" W x 36" H x 6.25" Ext.	90+	4000	1500	LED, DIM, LEAF, CCT
B	E42061	BBK, SN	44W PCB LED 3000-4000K (Inte.)	24" W x 30" H x 2.25" Ext.	90+	4000	1400	LED, DIM, LEAF, CCT, +, ♿, CCT
C	E42062	BBK, SN	50W PCB LED 3000-4000K (Inte.)	30" W x 36" H x 2.25" Ext.	90+	5300	1800	LED, DIM, LEAF, CCT, +, ♿, CCT
D	E42063	BBK, SN	55W PCB LED 3000-4000K (Inte.)	48" W x 30" H x 2.25" Ext.	90+	5800	2030	LED, DIM, LEAF, CCT, +, ♿, CCT
E	E42064	BBK, SN	60W PCB LED 3000-4000K (Inte.)	60" W x 28" H x 2.25" Ext.	90+	6600	2300	LED, DIM, LEAF, CCT, +, ♿, CCT

Finish Options: Brushed Black (BBK) Satin Nickel (SN)



# SAWYER LED MIRRORS

A wood-framed mirror is offered in a choice of Walnut or Distressed Oak, combining natural elements with modern functionality. A 2-inch frosted band along the frame's interior is backlit with LEDs, providing optimal illumination above a vanity. A discreetly hidden control along the edge of the frame allows easy selection between 3000K, 4000K, and 5000K color temperatures for personalized lighting.



# SAWYER LED MIRRORS

- Wood Framed LED Mirror
- Available in Walnut or Distressed Oak
- Discreet touch dimmable switch on frame
- CCT Selectable: 3000-4000-5000K
- Plug-in or Direct Wire
- CRI 90+



**E42052-OK, -WN**  
Mirror

**A**

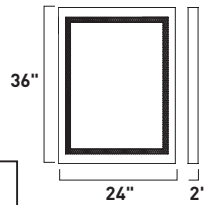

CCT SWITCH



**E42054-OK, -WN**  
Mirror

**B**

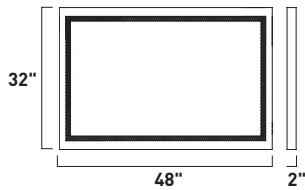

**E42057-OK, -WN**  
Free Standing/Wall Mirror

**C**

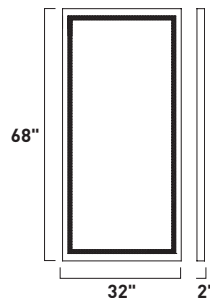

ITEM #	FINISH	LAMPING	DIMENSION	LUMENS			Additional Information	
				CRI	INIT.	DEL.		
A	E42052	OK, WN	52W PCB LED 3000-4000-5000K (Inte.)	24" W x 36" H x 2" Ext.	90+	5200	1800	
B	E42054	OK, WN	72W PCB LED 3000-4000-5000K (Inte.)	48" W x 32" H x 2" Ext.	90+	7200	2520	
C	E42057	OK, WN	86W PCB LED 3000-4000-5000K (Inte.)	32" W x 68" H x 2" Ext.	90+	8600	3000	

Finish Options: Oak (OK) Walnut (WN)









# Continuum TRACK

# CONTINUUM - TRACK

The next generation of track lighting is here with the ultra-slim Continuum series from ET2. Field adjustable track lengths can be extended, connected, or cut to fit the space they are installed. On them, a variety of low voltage light sources can be quickly snapped into place adding and directing light exactly where desired. Various power feed options are available including recessed, on-track, or integrated dimmable driver and switch. Available in Matte Black or Matte White, the track lengths can even be painted to match the exact paint color of the surfaces they are installed. This adaptable track system makes it simple to design the lighting in your space according to your vision and is only limited to your imagination.

## SURFACE MOUNTED CONNECTORS

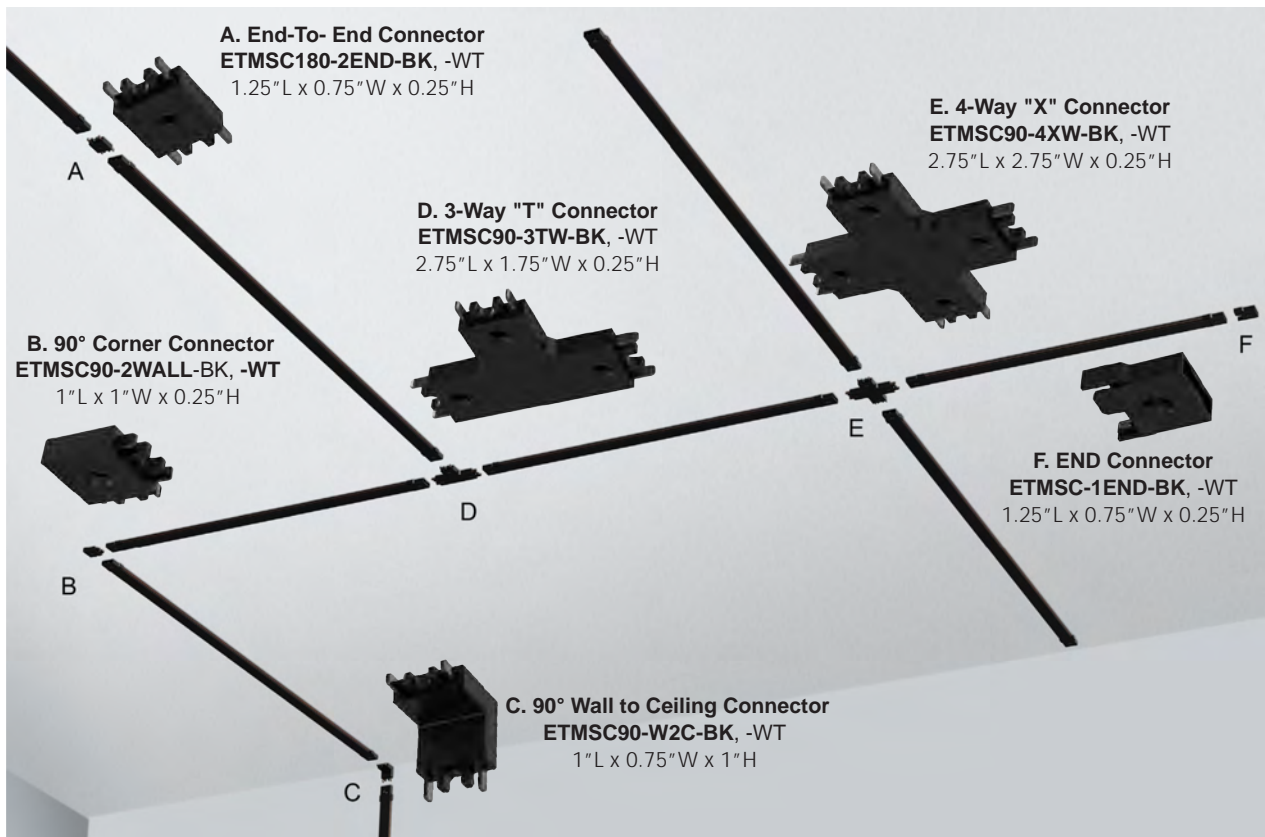

## SURFACE MOUNTED TRACK



- Surface Mount Installation
- Field Cuttable
- Various Track Connectors Adaptable
- Available in Black or White
- 3M Stickers Cover Screw Caps

ETRK25080-BK, -WT 33"L  
ETRK25150-BK, -WT 60"L  
ETRK25200-BK, -WT 80"L

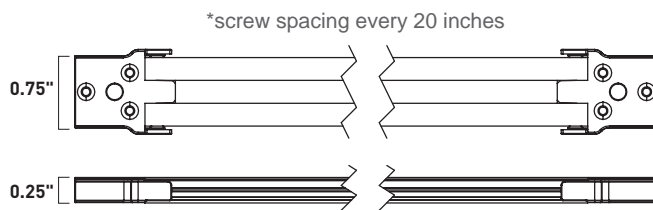

# CONTINUUM - TRACK

## REMOTE HARDWIRED DRIVER

## ON-TRACK DRIVER

24V Low Voltage Output  
Plug-In and Hardwire Options



**96W On-Track Driver**  
**ETDRV001-24100-BK, -WT**  
11.5" L x 1" W x 2.25" H  
Includes 48" Plug



**EDHW-2496AL**  
**Hardwire Driver**  
(Remote Installation)  
8.5" L x 3.25" W x 1.5" H

### INSTALL TRACK 3 WAYS



INSTALL OPTION: PLUG-IN



INSTALL OPTION: HARDWIRE KNOCKOUT

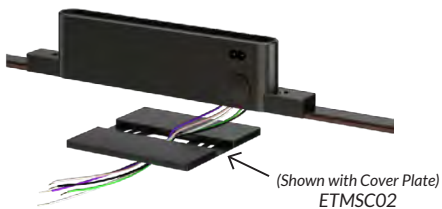

INSTALL OPTION: DISCREETLY WIRE WITHIN

## DRIVER & DIMMER SWITCH

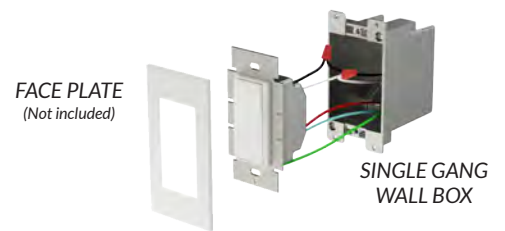

**60W Dimmer Switch**  
**SWT898-2460WT 60W**  
2.25" L x 2" W x 4.25" H

## SPLICE BOX



**Splice Box**  
**ETMSC04-BK, -WT**  
3.5" L x 1.5" W x 0.75" H



Track Length  
(Sold Separately)



## ELECTRICITY FEED & COVER PLATE



**Electricity Module and Cover Plate**  
(Driver not included)  
**ETMSC01-BK, -WT**  
5" L x 5" W x 0.25" H

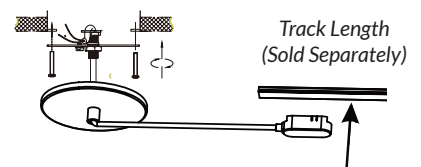

Track Length  
(Sold Separately)

## COVER PLATE ACCESSORIES



**Track Cover Plate**  
**ETMSC02-BK, -WT**  
5" L x 5" W x 0.25" H



**Track Cover Plate**  
**ETMSC03-BK, -WT**  
5" L x 5" W x 0.25" H

# CONTINUUM-TRACK LIGHT

- Flat Lens Diffuser with even light distribution
- Available with adjustable gimbal
- 3 Lengths Available: 5" - 9" - 13.5"
- 24V LED, 3000K Color Temperature

## STANDARD LENS

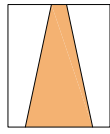

100° Standard lens

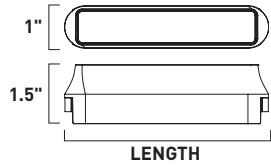

ETL26212-BK, -WT Track Light

A



ETL26216-BK, -WT Track Light

B



ETL26218-BK, -WT Track Light

C



ADJUSTABLE GIMBAL

ETL25212-BK, -WT Track Light

D

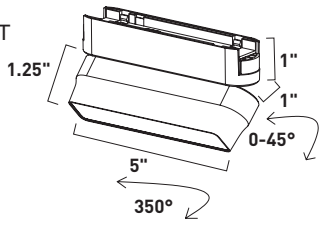

ETL25216-BK, -WT Track Light

E

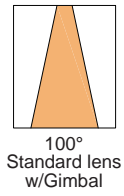
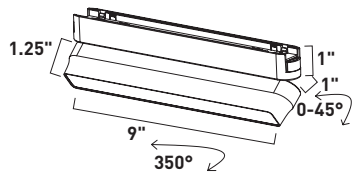

100° Standard lens w/Gimbal

ITEM #	FINISH	LAMPING	DIMENSION	LUMENS			Additional Information
				CRI	INIT.	DEL.	
A	ETL26212 BK, WT	6W PCB LED 3000K (Inte.)	5"L x 1"W x 1.5"H	90+	600	300	
B	ETL26216 BK, WT	9W PCB LED 3000K (Inte.)	9"L x 1"W x 1.5"H	90+	900	450	
C	ETL26218 BK, WT	12W PCB LED 3000K (Inte.)	13.5"L x 1"W x 1.5"H	90+	1500	750	
D	ETL25212 BK, WT	6W PCB LED 3000K (Inte.)	5"L x 1"W x 2.25"H	90+	600	300	
E	ETL25216 BK, WT	9W PCB LED 3000K (Inte.)	9"L x 1"W x 2.25"H	90+	900	450	

Finish Options: Black (BK) White (WT)

# OPTICAL LENS

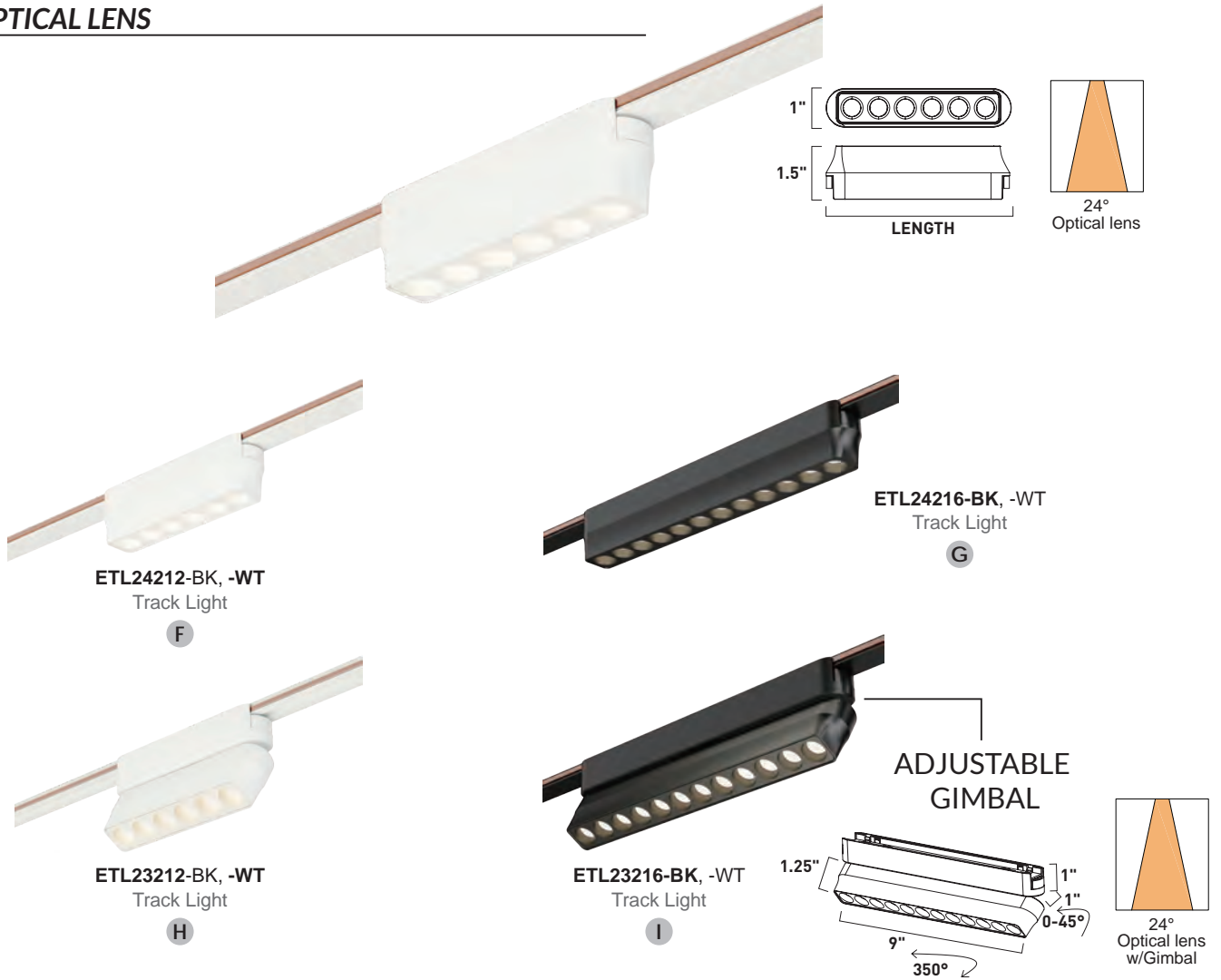

# ANTI-GLARE LENS

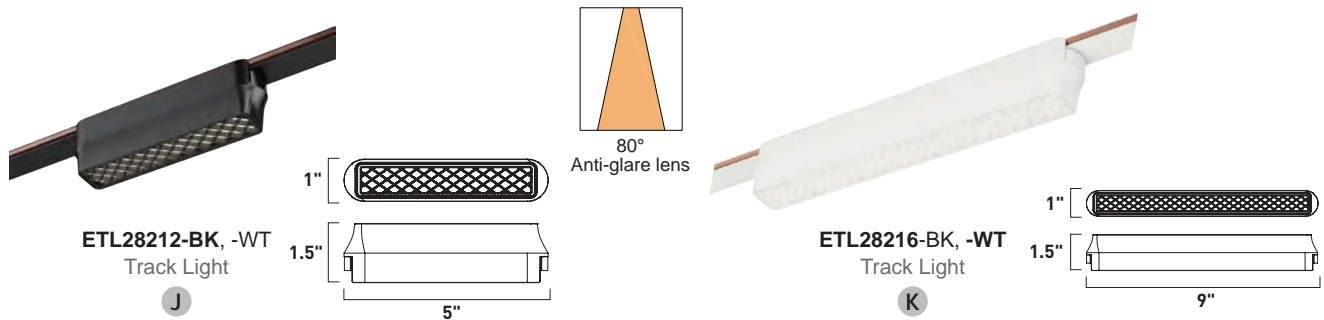

ITEM #	FINISH	LAMPING	DIMENSION	LUMENS			Additional Information
				CRI	INIT.	DEL.	
F	ETL24212 BK, WT	6W PCB LED 3000K (Inte.)	5" L x 1" W x 1.5" H	90+	550	450	
G	ETL24216 BK, WT	9W PCB LED 3000K (Inte.)	9" L x 1" W x 1.5" H	90+	800	675	
H	ETL23212 BK, WT	6W PCB LED 3000K (Inte.)	5" L x 1" W x 2.25" H	90+	550	450	
I	ETL23216 BK, WT	9W PCB LED 3000K (Inte.)	9" L x 1" W x 2.25" H	90+	800	675	
J	ETL28212 BK, WT	6W PCB LED 3000K (Inte.)	5" L x 1" W x 1.5" H	90+	600	250	
K	ETL28216 BK, WT	9W PCB LED 3000K (Inte.)	9" L x 1" W x 1.5" H	90+	900	350	

Finish Options: Black (BK) White (WT)



# CONTINUUM-SPOT LIGHT

- Spot Lights to direct light where needed
- Different apertures and lumen packages available
- Available in Black and White with Black interior
- Adjustable Beam Angle Model
- 24V Low Voltage LED 3000K Color Temperature

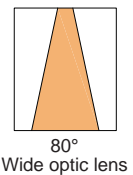
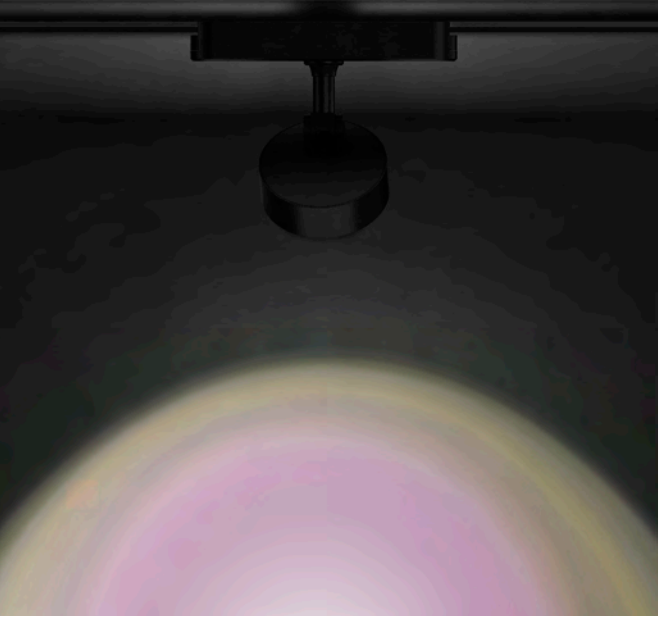

**ETL21214-BK, -WT**  
Track Light  
**A**

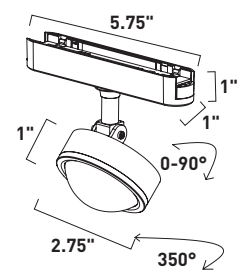

**SUNSET LENS**  
**ETL21214-114BK, -114WT**

ITEM #	FINISH	LAMPING	DIMENSION	LUMENS		Additional Information
				CRI	INIT. DEL.	
A ETL21214	BK, 114BK, WT, 114WT	5W PCB LED 3000K (Inte.)	5.75"L x 2.75"W x 4.25"H	90+	450 350	

Finish Options: Black (BK) White (WT)



**ETL21210-BK, -WTBK, -WT**  
Spot Light

**B**

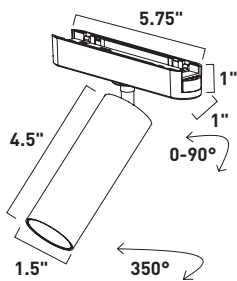

**ETL21211-BK, -WT**  
Spot Light

**C**

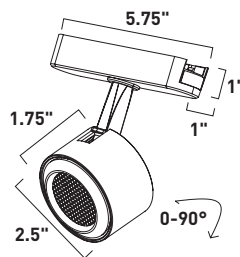

**ETL21212-BK, -WT**  
Spot Light

**D**

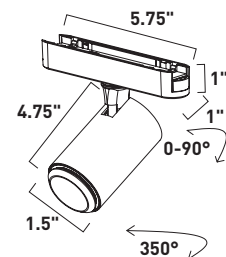

ITEM #	FINISH	LAMPING	DIMENSION	LUMENS			Additional Information
				CRI	INIT.	DEL.	
B	ETL21210 BK, WTBK, WT	7W PCB LED 3000K (Inte.)	5.75" L x 1.5" W x 5.75" H	90+	650	500	
C	ETL21211 BK, WT	12W PCB LED 3000K (Inte.)	5.75" L x 2.5" W x 4.25" H	90+	1100	850	
D	ETL21212 BK, WT	10W PCB LED 3000K (Inte.)	5.75" L x 2" W x 4.75" H	90+	900	300	

Finish Options: Black (BK) White/Black (WTBK) White (WT)

# CONTINUUM-TRACK LIGHT

- Corner Modules Illuminate at 90 degrees
- 24V Low Voltage LED, 3000K Color Temperature
- 90 degree single surface module
- 90 degree Wall to Ceiling Module
- Flat PMMA Acrylic Diffusers
- Available in Black and White

## Corner Light

90 degrees, Single surface



**ETL29212-BK, -WT**  
Track Light

**A**

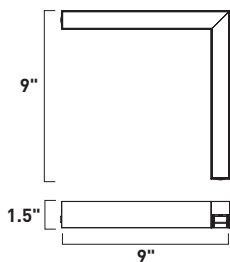

## Wall-to-Ceiling Light

90 degrees, Two Plane surface



**ETL29222-BK, -WT**  
Track Light

**B**

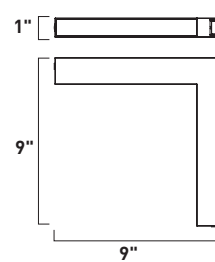

## WALL WASHERS

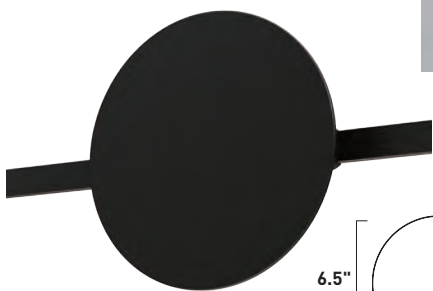

**ETL29223-BK**  
Track Wall Wash



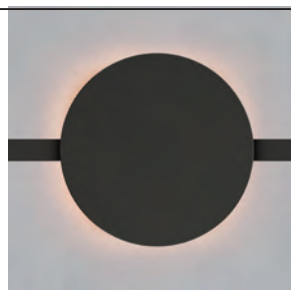
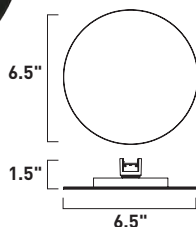





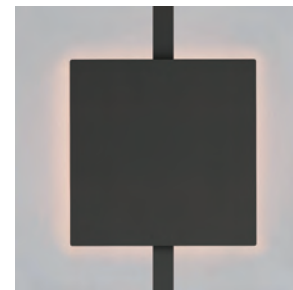
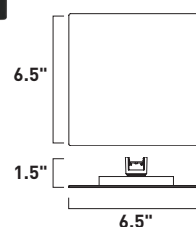







**C**



**ETL29224-BK**  
Track Wall Wash

**D**



ITEM #	FINISH	LAMPING	DIMENSION	CRI	LUMENS		Additional Information	
					INIT.	DEL.		
A	ETL29212	BK, WT	15W PCB LED 3000K (Inte.)	9"L x 9"W x 1.5"H	90+	1500	950	   
B	ETL29222	BK, WT	15W PCB LED 3000K (Inte.)	9"L x 1"W x 9"H	90+	1500	950	   
C	ETL29223	BK	5W PCB LED 3000K (Inte.)	6.5"L x 6.5"W x 1.5"H	90+	450	350	   
D	ETL29224	BK	5W PCB LED 3000K (Inte.)	6.5"L x 6.5"W x 1.5"H	90+	450	350	   

Finish Options: Black (BK) White (WT)

**TUBE LIGHT**

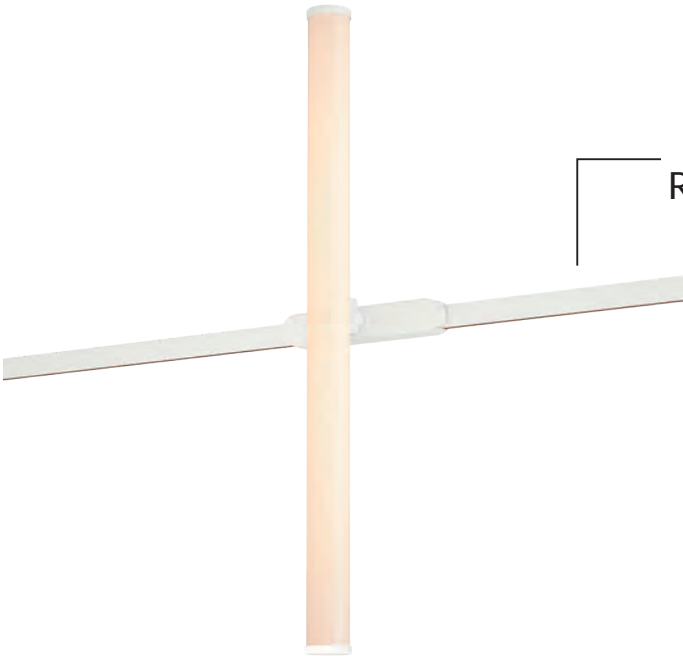

TUBE ROTATES



**ETL21232-BK, -WT**  
Track Tube Light

**E**

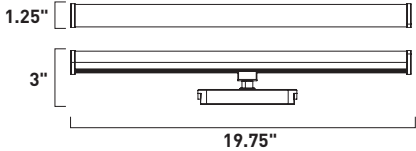

**READING LIGHT**



FLEXIBLE ARM HOLDS POSITION  
With Touch Switch

**ETL21216-BK, -BKGLD**  
Track Read Light

**F**

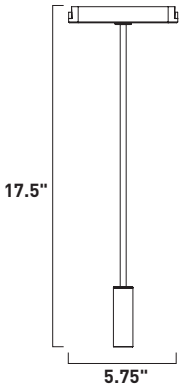

	ITEM #	FINISH	LAMPING	DIMENSION	LUMENS			Additional Information
					CRI	INIT.	DEL.	
E	ETL21232	BK, WT	12W PCB LED 3000K (Inte.)	19.75"L x 1.25"W x 3"H	90+	1100	850	LED, DALI, 3M, 5Y, 5Y
F	ETL21216	BK, BKGLD	2W PCB LED 3000K (Inte.)	5.75"L x 1"W x 17.5"H	90+	200	150	LED, DALI, 3M, 5Y, 5Y

Finish Options: Black (BK) White (WT) Black/Gold (BKGLD)



# CONTINUUM TRACK

ETL31003-WTBK  
Pendant

A

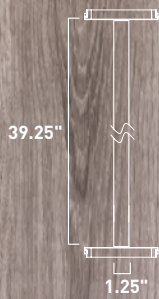

ETL31006-WTBK  
Pendant

B



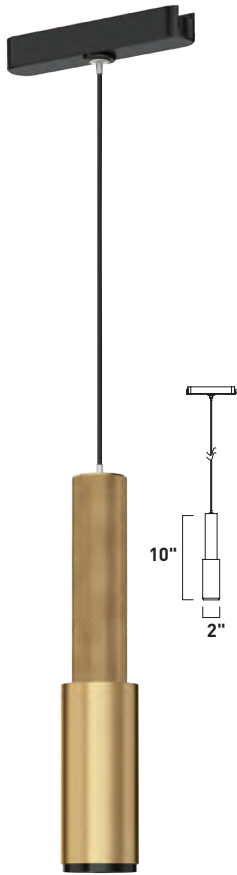

**ETL31622-BK, -NAB, -WT**  
Pendant  
**C**

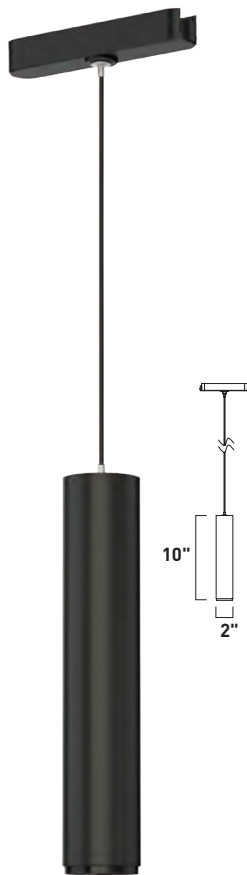

**ETL31022-BK, -NAB, -WT**  
Pendant  
**D**

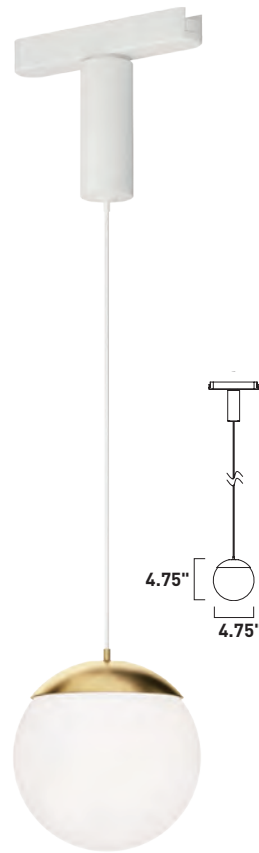

**ETL31013-WT, -WTNAB**  
Pendant  
**E**

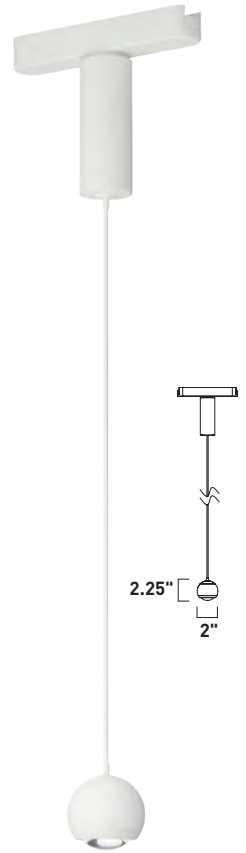

**ETL31251-BK, -NAB, -WT**  
Pendant  
**F**

ITEM #	FINISH	LAMPING	DIMENSION	LUMENS			Additional Information	
				CRI	INIT.	DEL.		
A	ETL31003	WTBK	12W PCB LED 3000K (Inte.)	39.25" L x 1.25" W	90+	600	600	LED DIM 12V
B	ETL31006	WTBK	20W PCB LED 3000K (Inte.)	78.5" L x 1.25" W	90+	1000	1000	LED DIM 12V
C	ETL31622	BK, NAB, WT	5W PCB LED 3000K (Inte.)	2" L x 2" W x 10" H, 69" OAH	90+	450	350	LED DIM 12V
D	ETL31022	BK, NAB, WT	5W PCB LED 3000K (Inte.)	2" L x 2" W x 10" H, 69" OAH	90+	450	350	LED DIM 12V
E	ETL31013	WT, WTNAB	5W PCB LED 3000K (Inte.)	4.75" L x 4.75" W x 4.75" H, 63.75" OAH	90+	450	350	LED DIM 12V
F	ETL31251	BK, NAB, WT	5W PCB LED 3000K (Inte.)	2" L x 2" W x 2.25" H, 61.25" OAH	90+	450	350	LED DIM 12V

Finish Options: Black (BK) Natural Aged Brass (NAB) White (WT)



# LINE 5CCT

An update to our popular Line series, the Line 5CCT uses a wider profile of aluminum with adjustable color temperatures. Simply toggle between the 5 settings: 2700-3000-3500-4000-5000K to suit the space where it is installed. Following the original design's premise, the Line is a straight and flat bar that indirectly casts light indirectly on the surface behind it.



# LINE 5CCT

- Indirect light source shines back towards surfaces behind it
- Anti corrosive aluminum construction
- Varying lengths from 18" to 96"
- CCT Selectable: 2700-3000-3500-4000-5000K
- Dimmable via Triac or ELV
- ADA Compliant



**E42348-ABZ, -BK, -SA, -WT**  
Outdoor Wall

**A**

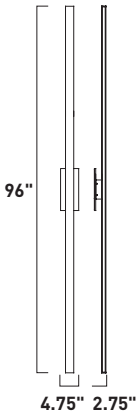

**E42344-ABZ, -BK, -SA, -WT**  
Outdoor Wall

**B**

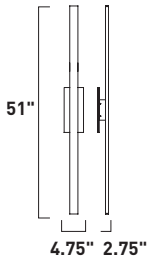

**E42342-ABZ, -BK, -SA, -WT**  
Outdoor Wall

**C**

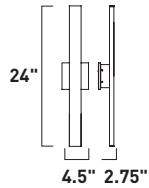

**E42341-ABZ, -BK, -SA, -WT**  
Outdoor Wall

**D**

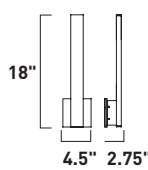

ITEM #	FINISH	LAMPING	DIMENSION	HCO CRI		LUMENS		Additional Information
				INIT.	DEL.	INIT.	DEL.	
A	ABZ, BK, SA, WT	2 x 30W LED 2700-3000-3500-4000-5000K (Inte.)	4.75"W x 96"H x 2.75"Ext.	48"	90+	4200	3500	
B	ABZ, BK, SA, WT	2 x 15W LED 2700-3000-3500-4000-5000K (Inte.)	4.75"W x 51"H x 2.75"Ext.	25.5"	90+	2100	1750	
C	ABZ, BK, SA, WT	2 x 13W LED 2700-3000-3500-4000-5000K (Inte.)	4.5"W x 24"H x 2.75"Ext.	12"	90+	1820	1250	
D	ABZ, BK, SA, WT	1 x 9W LED 2700-3000-3500-4000-5000K (Inte.)	4.5"W x 18"H x 2.75"Ext.	9"	90+	630	540	

Finish Options: Architectural Bronze (ABZ) Black (BK) Satin Nickel (SA) White (WT)



# SIDELINE OUTDOOR

A straight line profile of aluminum casts lights along the length of the profile in both directions with adjustable color temperatures. Available in powder coat finishes including: Black and Architectural Bronze.

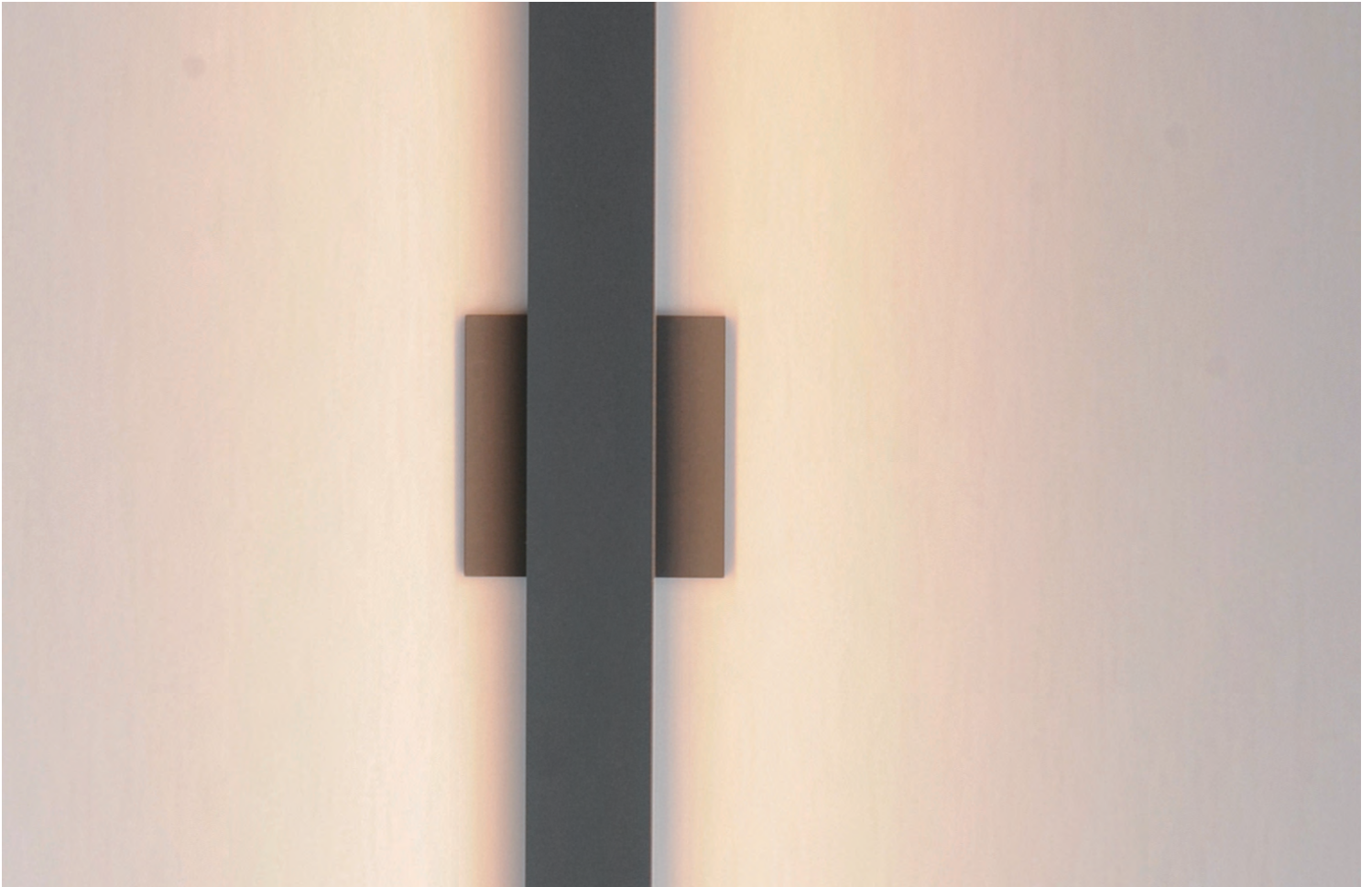

# SIDELINE

- Anti corrosive aluminum construction
- Varying lengths from 18" to 96"
- Dimmable via Triac or ELV
- Interior and Exterior configurations
- Outdoor rated powder coat options include: Black and Architectural Bronze
- ADA Compliant

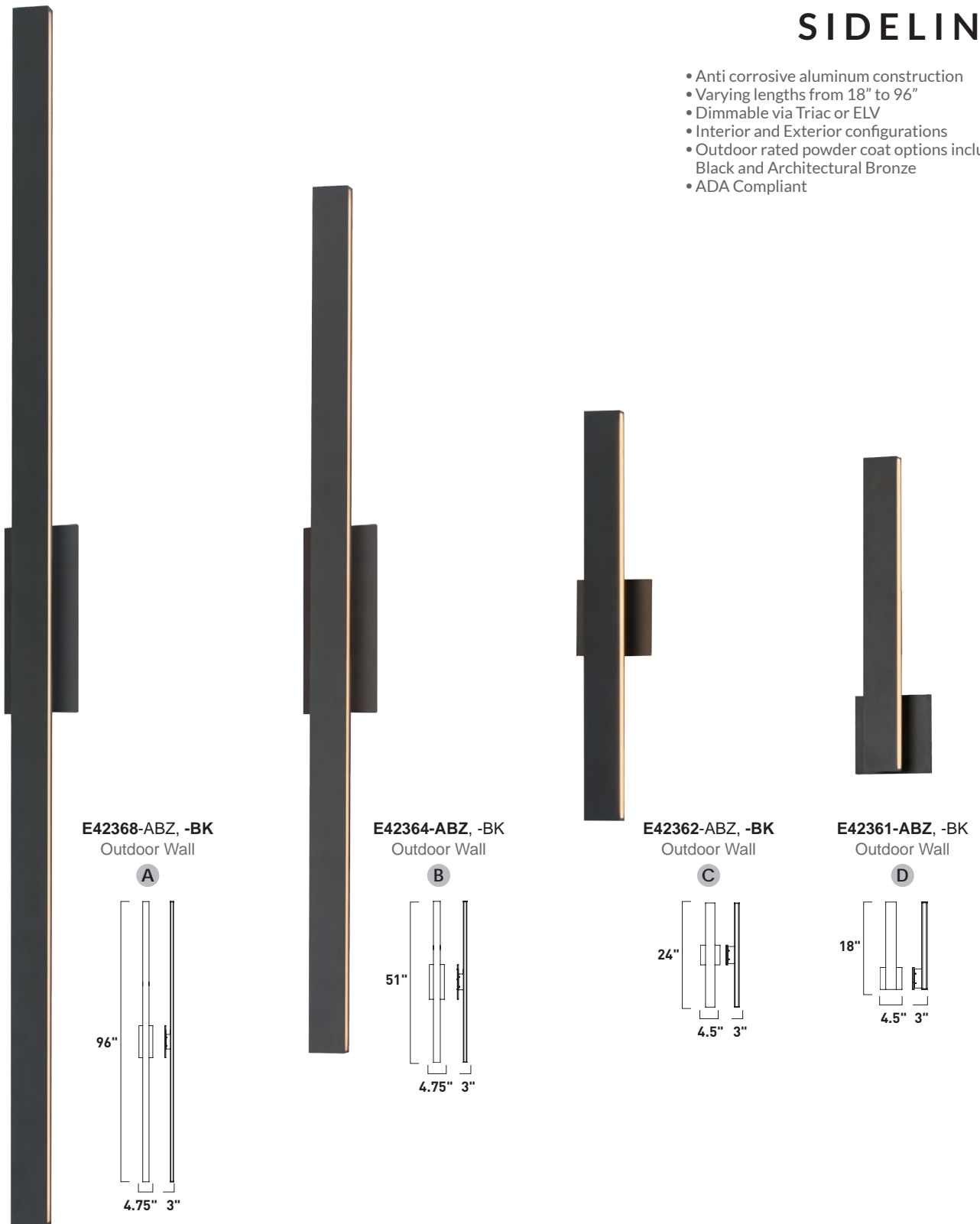

**E42368-ABZ, -BK**  
Outdoor Wall

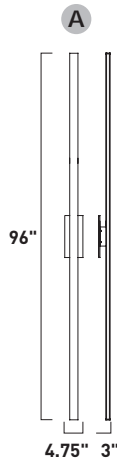

**E42364-ABZ, -BK**  
Outdoor Wall

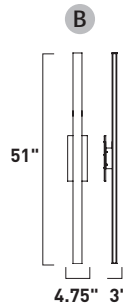

**E42362-ABZ, -BK**  
Outdoor Wall

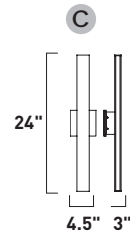

**E42361-ABZ, -BK**  
Outdoor Wall

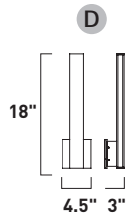

ITEM #	FINISH	LAMPING	DIMENSION	HCO	CRI	LUMENS		Additional Information
						INIT.	DEL.	
A	E42368 ABZ, BK	2 x 60W LED 3000K (Inte.)	4.75"W x 96"H x 3"Ext.	48"	90+	8400	6120	
B	E42364 ABZ, BK	2 x 30W LED 3000K (Inte.)	4.75"W x 51"H x 3"Ext.	25.5"	90+	4200	3000	
C	E42362 ABZ, BK	2 x 13W LED 3000K (Inte.)	4.5"W x 24"H x 3"Ext.	24"	90+	1820	1270	
D	E42361 ABZ, BK	2 x 9W LED 3000K (Inte.)	4.5"W x 18"H x 3"Ext.	9"	90+	1260	620	

Finish Options: Architectural Bronze (ABZ) Black (BK)

# CITADEL

Vertical aluminum strands surround an acrylic LED tube that shines omnidirectional light filtered by the frame. The thin profile of the overall column extends less than 4" offering ADA compliant applications. Available in a variety of sconce sizes, the design is finished in a matte Black finish that complements most settings.



# CITADEL

- Vertical struts of aluminum surround a cylindrical lamp body
- Integrated LED housed within acrylic tube with omnidirectional light
- Neutral 3000K Color Temperature
- ADA compliant
- 120-277V Input
- 3-in-1 dimming: Triac, ELV, and 0-10V



**E30318-BK**  
Outdoor Wall

**A**

28"



**E30316-BK**  
Outdoor Wall

**B**

24"

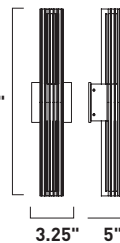

**E30314-BK**  
Outdoor Wall

**C**

15"

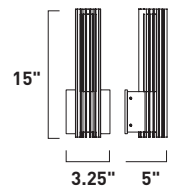

ITEM #	FINISH	LAMPING	DIMENSION	HCO	CRI	LUMENS		Additional Information
						INIT.	DEL.	
<b>A</b> E30318	BK	2 x 12W PCB LED 3000K (Inte.)	3.25"W x 28"H x 5" Ext.	14"	90+	2200	1600	
<b>B</b> E30316	BK	2 x 9.5W PCB LED 3000K (Inte.)	3.25"W x 24"H x 5" Ext.	12"	90+	1900	1300	
<b>C</b> E30314	BK	1 x 11W PCB LED 3000K (Inte.)	3.25"W x 15"H x 5" Ext.	12.5"	90+	1000	600	

Finish: Black (BK)



# GRATE

An array of precise slits are stacked in two columns on rectangular shade forms of various sizes. Housed in a blocked out space is a recessed LED light source that casts a filigree that radiate onto the surface surrounding the sconce making a dazzling display from the simple geometrical frame. Available in Matte Black or Architectural Bronze, the LED is a neutral 3000K.

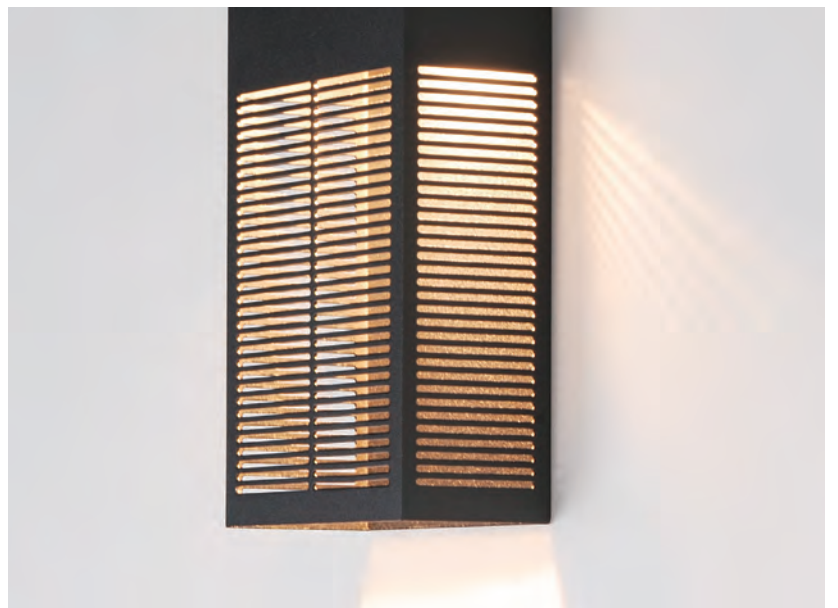

- An array of precise slits are stacked in two columns
- Recessed LED light source
- Neutral 3000K Color Temperature
- ADA compliant
- Dimmable with Triac or ELV



**E30392-ABZ, -BK**  
Outdoor Wall

**A**

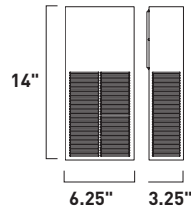

**E30393-ABZ, -BK**  
Outdoor Wall

**B**

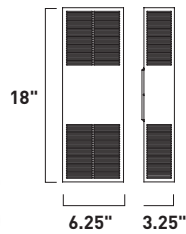

**E30394-ABZ, -BK**  
Outdoor Wall

**C**

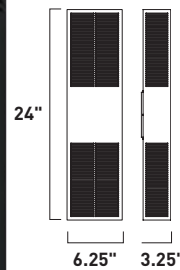

**E30395-ABZ, -BK**  
Outdoor Wall

**D**

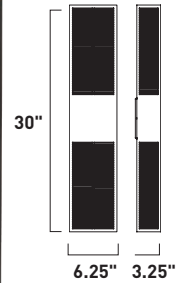

ITEM #	FINISH	LAMPING	DIMENSION	HCO	CRI	LUMENS		Additional Information	
						INIT.	DEL.		
A	E30392	ABZ, BK	1 x 10W PCB LED 3000K (Inte.)	6.25" W x 14" H x 3.25" Ext.	3"	90+	700	450	
B	E30393	ABZ, BK	2 x 12W PCB LED 3000K (Inte.)	6.25" W x 18" H x 3.25" Ext.	9"	90+	1680	890	
C	E30394	ABZ, BK	2 x 12W PCB LED 3000K (Inte.)	6.25" W x 24" H x 3.25" Ext.	12"	90+	1680	890	
D	E30395	ABZ, BK	2 x 12W PCB LED 3000K (Inte.)	6.25" W x 30" H x 3.25" Ext.	15"	90+	1680	890	

Finish Options: Architectural Bronze (ABZ) Black (BK)

# RAMPART

Sharp rectilinear metal lines surround a squared LED housing that shines both upwards and downwards, creating an intriguing pattern of light. This collection offers a full range of products that suits exterior and interiors without bounds. Available in a variety of sconce sizes, as well as an additional pendant and post mount option, the design is completed in a matte Black finish that complements most settings.

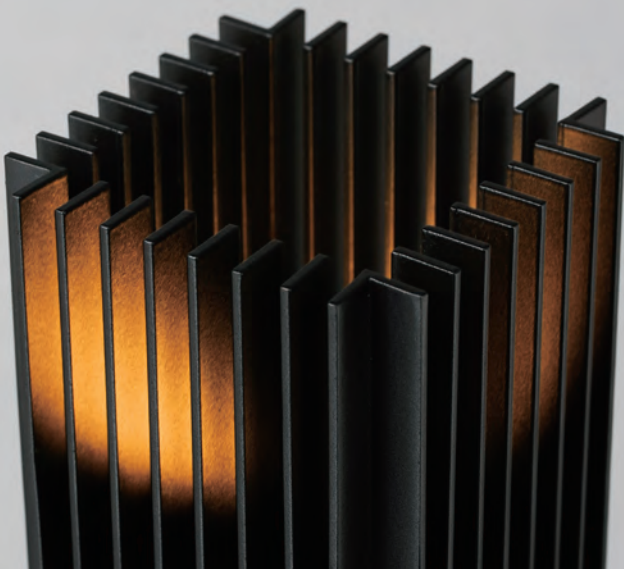



# RAMPART

- Corrosive-resistant Aluminum construction
- Squared rods surround LED housing
- Up/Down Lighting
- Dimmable LED light source, 3000K Color Temperature
- Wet Location Rated
- Available as a pendant, post mount, and 3 sizes of wall sconce in Matte Black



**E30119-BK**  
Outdoor Pendant

**B**

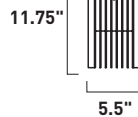

**E30110-BK**  
Outdoor Post

**A**

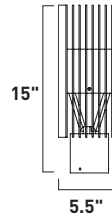

**E30112-BK**  
Outdoor Wall

**C**

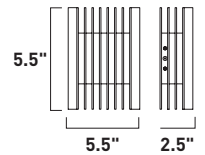

	ITEM #	FINISH	LAMPING	DIMENSION	BP	HCO	CRI	LUMENS		Additional Information
								INIT.	DEL.	
<b>A</b>	E30110	BK	2 x 6W PCB LED 3000K (Inte.)	5.5"W x 15"H			90+	840	600	LED, DIM, WTT, UP/DN
<b>B</b>	E30119	BK	2 x 6W PCB LED 3000K (Inte.)	5.5"W x 11.75"H, 60" OAH			90+	840	600	LED, DIM, WTT, UP/DN, ♿
<b>C</b>	E30112	BK	2 x 4W PCB LED 3000K (Inte.)	5.5"W x 5.5"H x 2.5" Ext.	4.5"W x 4.5"H	4"	90+	540	300	LED, DIM, WTT, ♿, UP/DN

Finish: Black (BK)



# RAMPART

- Corrosive-resistant Aluminum construction
- Squared rods surround LED housing
- Up/Down Lighting
- Dimmable LED light source, 3000K Color Temperature
- Wet Location Rated
- Available as a pendant, post mount, and 3 sizes of wall sconce in Matte Black



**E30114-BK**  
Outdoor Wall

**A**

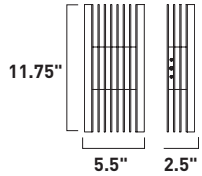

**E30116-BK**  
Outdoor Wall

**B**

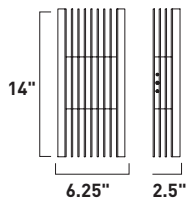

ITEM #	FINISH	LAMPING	DIMENSION	BP	HCO	CRI	LUMENS		Additional Information	
							INIT.	DEL.		
A	E30114	BK	2 x 6W PCB LED 3000K (Inte.)	5.5"W x 11.75"H x 2.5"Ext.	4.5"W x 4.5"H	6"	90+	840	600	
B	E30116	BK	2 x 6W PCB LED 3000K (Inte.)	6.25"W x 14"H x 2.5"Ext.	4.25"W x 3"H	7"	90+	840	600	

Finish: Black (BK)



**E30117-BK**  
Outdoor Wall

**C**

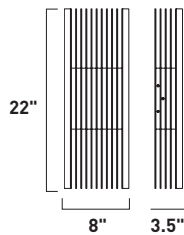

**E30118-BK**  
Outdoor Wall

**D**

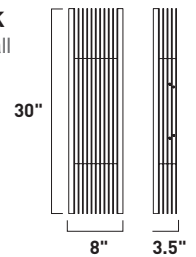

ITEM #	FINISH	LAMPING	DIMENSION	BP	HCO	CRI	LUMENS		Additional Information
							INIT.	DEL.	
<b>C</b> E30117	BK	2 x 15W PCB LED 3000K (Inte.)	8"W x 22"H x 3.5"Ext.	5.25"W x 5.25"H	11"	90+	1500	1060	
<b>D</b> E30118	BK	2 x 15W PCB LED 3000K (Inte.)	8"W x 30"H x 3.5"Ext.	8"W x 15"H	15"	90+	3000	1000	

Finish: Black (BK)

# TERRA

An line of indirect LED lighting shines back on a rough-hewn cast aluminum plate with an erosion pattern that curves slightly at its ends. The neutral 3000K color temperature casts warm lighting that creates shadows and depth on the fixtures surface. An earthy organic composition available in Matte Black and Architextural Bronze, these sconces will elevate a space whether it be used in a wet exterior application or interior. An extension of less than 4" makes these sconces ADA compliant.

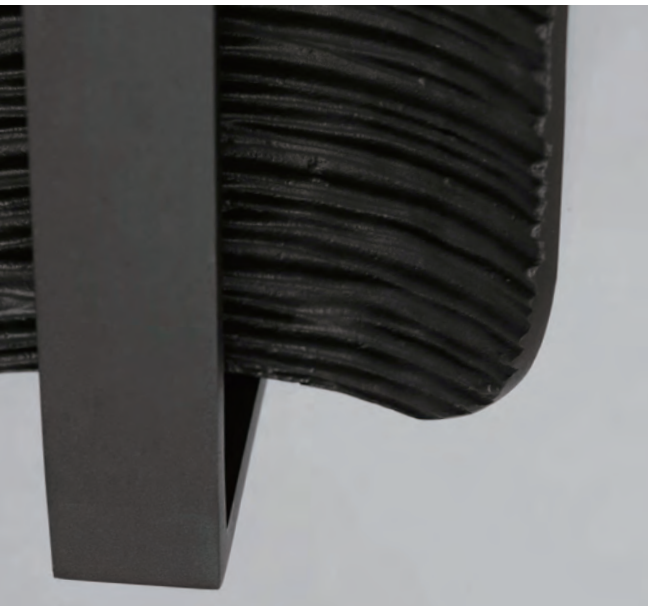

- Cast aluminum body with deep ridge texture
- Indirect LED light source shines on the fixture's surface
- Neutral 3000K Color Temperature
- ADA compliant
- Dimmable with Triac or ELV

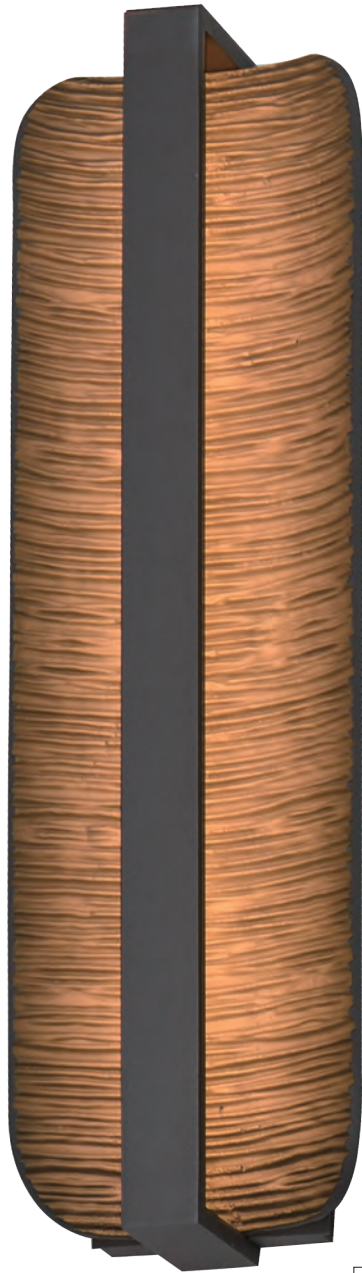

**E30363-ABZ**  
Outdoor Wall

**A**

24.5"

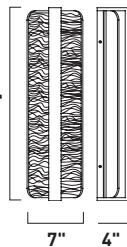

**E30362-ABZ**  
Outdoor Wall

**B**

16"

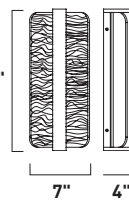

	ITEM #	FINISH	LAMPING	DIMENSION	HCO	CRI	LUMENS		Additional Information
							INIT.	DEL.	
<b>A</b>	E30363	ABZ	1 x 28W PCB LED 3000K (Inte.)	7"W x 24.5"H x 4"Ext.	12.25"	90+	1950	900	
<b>B</b>	E30362	ABZ	1 x 22W PCB LED 3000K (Inte.)	7"W x 16"H x 4"Ext.	8"	90+	1500	750	

Finish: Architectural Bronze (ABZ)



# STEPPEES

A slim profile extends from the wall with sharply angled facets. Available in various sizes and your choice of Matte Black or Antique Bronze finish, its scale allows it to function both as a step light and as a subtle LED outdoor wall sconce. Concealed within the top housing is an integrated LED light that casts light downward on a series of ridges capturing various intensities of light.



# STEPPEES

- Matte Black or Antique Bronze finish
- Stepped striation pattern along the frame
- LED Integrated, 3000K Color Temperature
- 120-277V Range Voltage Input
- 3-in-1 universal dimming: Triac/ELV at 120V or 0-10V dimming
- Suitable for use in Wet Locations



**E41552-ANB, -BK**  
Outdoor Wall

**A**

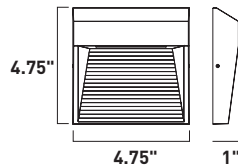

**E41554-ANB, -BK**  
Outdoor Wall

**B**

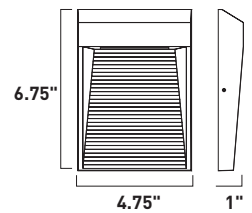

**E41556-ANB, -BK**  
Outdoor Wall

**C**

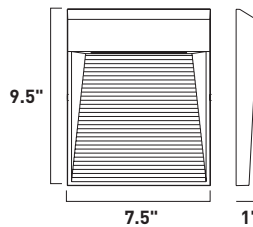

ITEM #	FINISH	LAMPING	DIMENSION	HCO	CRI	LUMENS INIT.	LUMENS DEL.	Additional Information
A	E41552 : ANB, BK	10W PCB LED 3000K (Inte.)	4.75" W x 4.75" H x 1" Ext.	2.25"	90+	800	240	LED DALI VTR
B	E41554 : ANB, BK	10W PCB LED 3000K (Inte.)	4.75" W x 6.75" H x 1" Ext.	3.25"	90+	800	240	LED DALI VTR
C	E41556 : ANB, BK	20W PCB LED 3000K (Inte.)	7.5" W x 9.5" H x 1" Ext.	4.75"	90+	2000	930	LED DALI VTR

Finish Options: Antique Bronze (ANB) Black (BK)



# BLOK

The classic cube form has become a staple in modern lighting design. These products have been designed with minimal extension for ADA compliance. The smaller downlight size is designed for Night Sky applications, while both sizes may be utilized in corridor areas for commercial and hospitality applications. This product range is not only commercially qualified, but also reasonably priced, with IP classifications that enable install in both indoors and outdoor areas. The high-powered LED light engine is low-voltage and comes with a range voltage driver, making it easier to fulfill a variety of site requirements.



- Cubes constructed of corrosive-resistant Aluminum
- ADA Compliant
- Down-light and Up/Down Light Configurations
- Range voltage 120-277V drivers included
- Dimmable LED light source, 3000K Color Temperature
- Wet Location Rated



**E23216-BK, -WT**  
Outdoor Wall

**A**

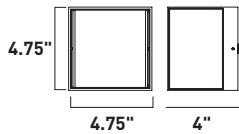

**E23218-BK, -WT**  
Outdoor Wall

**B**

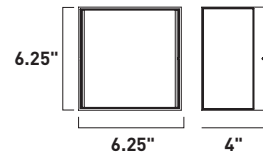

**REMOVABLE BACKPLATE**

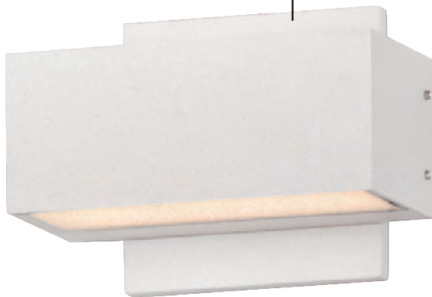

**E23217-BK, -WT**  
Outdoor Wall

**C**

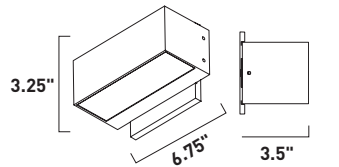

**E23219-BK, -WT**  
Outdoor Wall

**D**

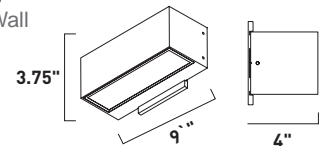

ITEM #	FINISH	LAMPING	DIMENSION	HCO CRI		LUMENS		Additional Information	
				INIT.	90+	INIT.	DEL.		
A	E23216	BK, WT	1 x 8W PCB LED 3000K (Inte.)	4.75" W x 4.75" H x 4" Ext.	2.25"	90+	630	440	
B	E23218	BK, WT	2 x 8W PCB LED 3000K (Inte.)	6.25" W x 6.25" H x 4" Ext.	3.25"	90+	1080	820	
C	E23217	BK, WT	2 x 9W PCB LED 3000K (Inte.)	6.75" W x 3.25" H x 3.5" Ext.	2.25"	90+	1080	1480	
D	E23219	BK, WT	2 x 12W PCB LED 3000K (Inte.)	9" W x 3.75" H x 4" Ext.	2.25"	90+	2400	1980	

Finish Options: Black (BK) White (WT)



# TREE HUGGER

LED spot light modules are connected with positionable joints designed to strap along vegetation and posts. Available in groupings of three, five, and eight, each section is supplied with a fabric strap to easily wrap the products around various structures. These are low voltage rated for inputs of 12-24V and require a landscape transformer that is not provided.



# TREE HUGGER

- Comes with in-ground spike and Adjustable Belt for wrapping on elevated structures or vegetation
- 12-24V low voltage input
- Outdoor Landscape Transformer Required (not included)



**E42313-BK**  
Spot Light

**A**

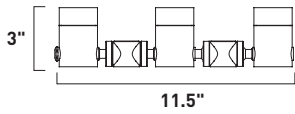

**E42315-BK**  
Spot Light

**B**

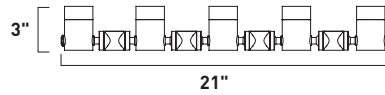

**E42318-BK**  
Spot Light

**C**

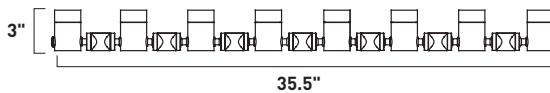

ITEM #	FINISH	LAMPING	DIMENSION	CRI	LUMENS		Additional Information	
					INIT.	DEL.		
A	E42313	BK	3 x 5W LED 3000K (Incl.)	11.5"W x 3"H	90+	1500	1030	
B	E42315	BK	5 x 5W LED 3000K (Incl.)	21"W x 3"H	90+	2500	1620	
C	E42318	BK	8 x 5W LED 3000K (Incl.)	35.5"W x 3"H	90+	4000	1890	

Finish: Black (BK)

# LANDSCAPE

Low voltage garden lights consisting of classic shaped shades to brighten your outdoor space. Choose from various lighting elements that pair with matching poles. In-ground stakes or bolt down installation mounting options are provided with a 16-inch pole. Extension rods in 8-inch increments sold separately.



**E41350-BK, -BZ, -SA**  
Pathway Light

**A**

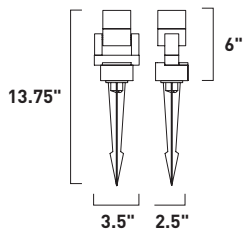

**E41356-BK**  
Pathway Light

**B**

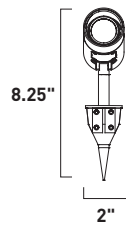

**E41359-BK**  
Pathway Light

**C**

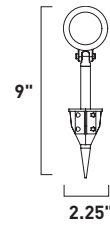

ITEM #	FINISH	LAMPING	DIMENSION	CRI	LUMENS INIT.	DEL.	Additional Information
A	E41350 BK, BZ, SA	5W MR16 LED 3000K (Incl.)	3.5"W x 13.75"H	90+	490	360	LED, MR16, 12V
B	E41356 BK	9W COB LED 3000-4000-6000K (Inte.)	2"W x 8.25"H	90+	900	530	LED, COB, 12V
C	E41359 BK	5W MR16 LED 3000K (Incl.)	2.25"W x 9"H	90+	490	360	LED, MR16, 12V

Finish Options: Black (BK) Bronze (BZ) Satin Aluminum (SA)

# LANDSCAPE

- LED Integrated, 3000K Color Temperature
- 12-24V Low Voltage Input
- Outdoor Landscape Transformer required (not included)



• Installed as Wall Mount (with Wall Plate)

**E41352-BK**  
Pathway Light

**D**

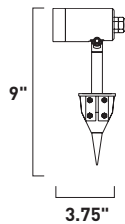

• Installed as Wall Mount (with Wall Plate)

**E41355-BK**  
Pathway Light

**F**

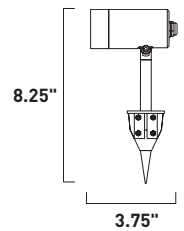

• Installed as Wall Mount (with Wall Plate)

**E41354-BK, -BZ, -SA**  
Pathway Light

**E**

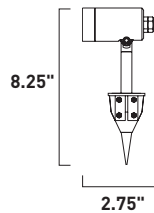

ITEM #	FINISH	LAMPING	DIMENSION	CRI	LUMENS INIT.	LUMENS DEL.	Additional Information
D	E41352 BK	5W MR16 LED 3000K (Incl.)	3.75"L x 2.25"W x 9"H	90+	490	360	LED 12V
E	E41354 BK, BZ, SA	5W PCB LED 3000K (Inte.)	2.75"L x 1.5"W x 8.25"H	90+	500	410	LED 12V
F	E41355 BK	8W PCB LED 3000K (Inte.)	3.75"L x 1.75"W x 8.25"H	90+	560	400	LED 12V

Finish Options: Black (BK) Bronze (BZ) Satin Aluminum (SA)



# LANDSCAPE

- LED Integrated, 3000K Color Temperature
- 12-24V Low Voltage Input
- Outdoor Landscape Transformer required (not included)



E41450-BK (with 16" Pole)  
**E41450-BK-24** (with 24" Pole)  
 Pathway Light

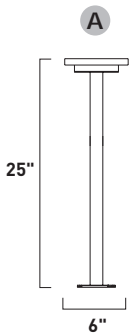

E41451-BK (with 16" Pole)  
**E41451-BK-24** (with 24" Pole)  
 Pathway Light

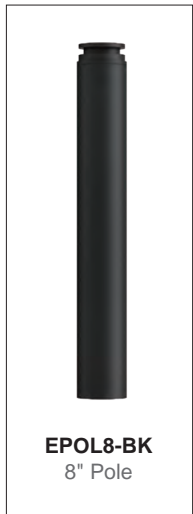
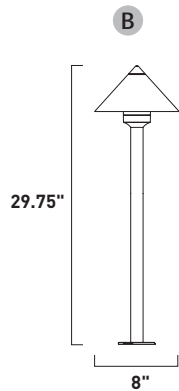

**EPOL8-BK**  
 8" Pole

ITEM #	FINISH	LAMPING	DIMENSION	CRI	LUMENS INIT. DEL.	Additional Information
A E41450	BK	12W PCB LED 3000K (Inte.)	6"W x 17.25"H	90+	980 710	With 16" pole, 12V
A E41450-24	BK	12W PCB LED 3000K (Inte.)	6"W x 25"H	90+	980 710	With 24" pole, 12V
B E41451	BK	7W PCB LED 3000K (Inte.)	8"W x 21.75"H	90+	490 290	With 16" pole, 12V
B E41451-24	BK	7W PCB LED 3000K (Inte.)	8"W x 29.75"H	90+	490 290	With 24" pole, 12V

Finish: Black (BK)





**E41452-61BK** (with 16" Pole)  
**E41452-61BK-24** (with 24" Pole)  
 Pathway Light

**C**

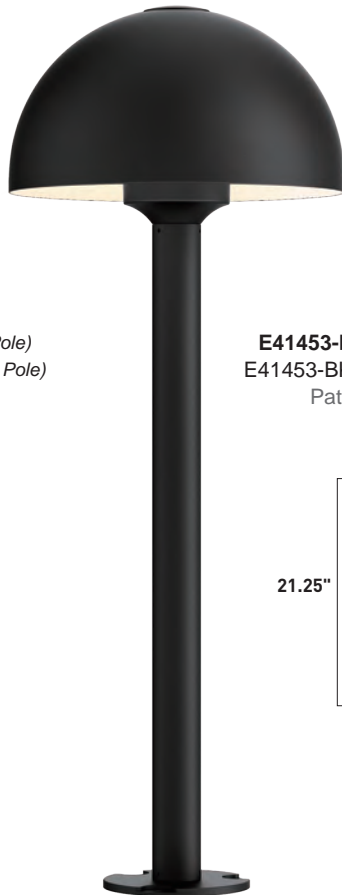
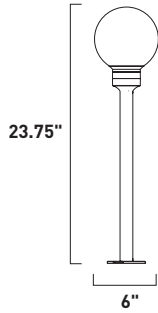

**E41453-BK** (with 16" Pole)  
**E41453-BK-24** (with 24" Pole)  
 Pathway Light

**D**

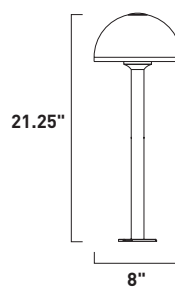

**E41455-10BK** (with 16" Pole)  
**E41455-10BK-24** (with 24" Pole)  
 Pathway Light

**E**

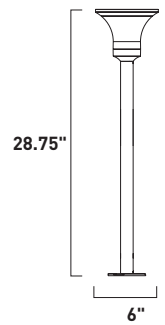

	ITEM #	FINISH	LAMPING	DIMENSION	CRI	LUMENS INIT.	DEL.	Additional Information
C	E41452	61BK	7W PCB LED 3000K (Inte.)	6"W x 23.75"H	90+	490	440	With 16" pole, 12V
C	E41452-24	61BK	7W PCB LED 3000K (Inte.)	6"W x 31.5"H	90+	490	440	With 24" pole, 12V
D	E41453	BK	7W PCB LED 3000K (Inte.)	8"W x 21.25"H	90+	490	260	With 16" pole, 12V
D	E41453-24	BK	7W PCB LED 3000K (Inte.)	8"W x 29"H	90+	490	260	With 24" pole, 12V
E	E41455	10BK	12W PCB LED 3000K (Inte.)	6"W x 20.75"H	90+	840	690	With 16" pole, 12V
E	E41455-24	10BK	12W PCB LED 3000K (Inte.)	6"W x 28.75"H	90+	840	690	With 24" pole, 12V

Finish: Clear/White glass (10) White Acrylic (61) Black (BK)

LETCAT2501-I



A MAXIM GROUP COMPANY

**#ET2lighting**

253 North Vineland Avenue  
City of Industry, California  
91746  
USA

General Info: 626.956.4200  
Customer Service: 800.486.2946  
General Fax: 626.956.4226  
Dallas Showroom: 3901  
Email: [Webinfo@et2online.com](mailto:Webinfo@et2online.com)  
ET2 Web Address: [www.et2online.com](http://www.et2online.com)



ET2 Contemporary Lighting and all designs,  
logos and images © 2025 ET2 Contemporary  
Lighting. All Rights Reserved.